



Hardware User Guide



Trademark Notices

Control, DeviceMaster, and PortVision are registered trademarks of Comtrol Corporation.

Ethernet is a registered trademark of Digital Equipment Corporation, Intel, and Xerox Corporation.

Microsoft and Windows are registered trademarks of Microsoft Corporation in the United States and/or other countries.

Modbus is a registered trademark of Schneider Electric.

PLC is a registered trademark of Allen-Bradley Company, Inc.

RedBoot is a trademark of Red Hat, Inc.

Portions of SocketServer are copyrighted by GoAhead Software, Inc. Copyright © 2001. GoAhead Software, Inc. All Rights Reserved.

Other product names mentioned herein may be trademarks and/or registered trademarks of their respective owners.

Second Edition, July 18, 2014

Copyright © 2005 - 2014. Comtrol Corporation.

All Rights Reserved.

Comtrol Corporation makes no representations or warranties with regard to the contents of this document or to the suitability of the Comtrol product for any particular purpose. Specifications subject to change without notice. Some software or features may not be available at the time of publication. Contact your reseller for current product information.

Table of Contents

Getting Started	5
Quick Start	5
Locating Software and Documentation	6
Hardware Installation.....	9
Configuring the DeviceMaster UP	11
PortVision DX Overview	11
PortVision DX Requirements.....	12
Installing PortVision DX.....	12
Configuring the Network Settings	16
Checking the Protocol Firmware Version.....	19
Uploading Protocol-Specific Firmware on the DeviceMaster UP	20
Customizing PortVision DX	22
Accessing DeviceMaster UP Documentation from PortVision DX	23
How to Download Documentation	23
How to Open Previously Downloaded Documents	24
Connecting Serial Devices	25
RJ45 Null-Modem Cables (RS-232)	26
RJ45 Null-Modem Cables (RS-422)	26
RJ45 Straight-Through Cables (RS-232/485)	26
RJ45 Loopback Plugs.....	27
RJ45 RS-485 Test Cable	27
Connecting RJ45 Devices	27
Managing the DeviceMaster UP	29
Rebooting the DeviceMaster UP	29
Uploading Firmware to Multiple DeviceMaster UPs.....	30
Configuring Multiple DeviceMaster UPs Network Addresses.....	31
Adding a New Device in PortVision DX	31
Remote Using the IP Address	31
Local Using the IP Address or MAC Address	32
Using Configuration Files	33
Saving a Configuration File	33
Loading a Configuration File	34
Managing Bootloader	35
Checking the Bootloader Version.....	35
Uploading Bootloader	35
Accessing RedBoot Commands in Telnet/SSH Sessions (PortVision DX)	37

- RedBoot Procedures.....41**
 - Accessing RedBoot Overview 41
 - Establishing a Serial Connection 42
 - Establishing a Telnet Connection..... 43
 - Determining the Network Settings 44
 - Configuring the Network Settings 44
 - Changing the Bootloader Timeout 45
 - Determining the Bootloader Version..... 45
 - Resetting the DeviceMaster UP 46
 - Configuring Passwords 46
 - RedBoot Command Overview..... 47

- Hardware Specifications49**
 - Locating DeviceMaster UP Specifications 49
 - External Power Supply Specifications..... 49
 - Notices..... 50
 - Radio Frequency Interference (RFI) (FCC 15.105)..... 50
 - Labeling Requirements (FCC 15.19) 50
 - Modifications (FCC 15.21)..... 50
 - Serial Cables (FCC 15.27) 50
 - Underwriters Laboratory 50
 - Important Safety Information..... 50

- Troubleshooting and Technical Support.....51**
 - Troubleshooting Checklist 51
 - General Troubleshooting..... 52
 - DeviceMaster UP LEDs 53
 - TX/RX LEDs..... 53
 - Network and Device LEDs 53
 - Technical Support 54

Getting Started

This guide discusses initial DeviceMaster UP installation and hardware configuration for the DeviceMaster UP with 16-ports.

This guide does not discuss configuring the port characteristics or protocol-specific programming information. See [Locating Software and Documentation](#) on Page 6 to locate the firmware and the appropriate documentation for your environment.

Note: *If you have a DeviceMaster UP with 1, 2, or 4-ports, use the [DeviceMaster UP Hardware Installation and Configuration Guide](#) because the RJ45 connectors have different pin outs.*

Quick Start



Installation and configuration follows these steps.



1. Connect the hardware (Page 15).
2. Install PortVision DX (Page 12).
3. Configure the DeviceMaster UP network settings (Page 16).
4. If necessary, install or update the firmware on the DeviceMaster UP for your protocol (Page 20).
5. Use [Locating Software and Documentation](#) on Page 6 to locate the appropriate installation document for your protocol so that you can perform the following procedures:
 - Configure port characteristics using the *Server Configuration* web page.
 - Program the PLCs.
6. Connect the serial device or devices (Page 91).

Locating Software and Documentation

You can access the appropriate firmware assembly, PortVision DX, and the *DeviceMaster UP* documentation from the CD shipped with the DeviceMaster UP or you can download the latest files using the links in the appropriate table:

- Software and firmware, which is independent of the protocol loaded (below)
- [Modbus Router Firmware and Documentation](#) on Page 7

DeviceMaster UP Software and Firmware		FTP
PortVision DX	<p><i>PortVision DX</i> is the application for Windows that you use to configure network settings and upload the firmware for your protocol.</p> <p>Use PortVision DX to manage Control Ethernet-attached devices to:</p> <ul style="list-style-type: none"> • Scan the network for attached devices • View networked devices in real-time • Access product-specific network settings configurations • Assign IP addresses and network settings to one or multiple devices • Upload the latest firmware or Bootloader • Save and load configuration files • Access DeviceMaster UP configuration web pages • Access Telnet/SSH sessions • Remotely reboot devices • Download technical documentation • Enable event logging to assist in monitoring and troubleshooting • Create shortcuts to quickly access your favorite applications • Organize devices into folders and create multiple views <p>Enter notes about a folder or device</p>	
Bootloader	<p><i>Bootloader</i>, the operating system that runs on the DeviceMaster UP hardware during the power on phase, which then starts the default application (either Modbus Router or SocketServer).</p> <p>SocketServer is the default application on DeviceMaster UPs ordered without a protocol loaded.</p>	

Modbus Router Firmware and Documentation		FTP
Firmware	<p>Modbus Router (.msi) contains the firmware and supporting files. The firmware provides embedded configuration web pages. You may need to update the DeviceMaster UP with the latest version.</p> <p>Depending on the model you purchased, the DeviceMaster UP may or may not have the Modbus Router firmware loaded.</p> <p>Note: <i>Models that have a protocol loaded on the DeviceMaster UP are identified in PortVision DX and the DeviceMaster UP is labeled accordingly.</i></p>	
Documentation	<ul style="list-style-type: none"> • <i>DeviceMaster UP 16-Port Hardware Installation and Configuration Guide</i> (this guide) contains hardware installation, PortVision DX installation, and firmware updating procedures. • <i>Modbus Router User Guide</i> contains detailed protocol-specific information about the DeviceMaster UP and configuration procedures. 	

Hardware Installation

Use the following procedure to install the DeviceMaster UP 16-port with an external power supply.

1. Place the DeviceMaster UP on a stable surface.

Note: Do not connect multiple units until you have changed the default IP address, see [Initial Configuration](#) on Page 35.

2. Connect the DeviceMaster UP to the same Ethernet network segment as the host PC using either port labeled **10/100** using a standard Ethernet cable.

Do not connect RS-422/485 devices until the appropriate port interface type has been configured. The default port setting is RS-232.

3. Apply power to the DeviceMaster UP by connecting the AC power adapter to the DeviceMaster UP, the power cord to the power adapter, and plugging the power cord into a power source. See [External Power Supply Specifications](#) on Page 49 if you want to provide your own power supply.

4. Verify that the STAT LED has completed the boot cycle and network connection for the DeviceMaster UP is functioning properly.

Note: The RX/TX LEDs cycle during a reboot.

- **STAT (Status LED)** - If the Status LED on the DeviceMaster LT is lit, it indicates the DeviceMaster LT has power and it has completed the boot cycle.

The STAT LED flashes while booting and it takes approximately 15 seconds for the Bootloader to complete the cycle. When the Bootloader completes the cycle, the LED has a solid, steady light that blinks approximately every 10 seconds.

- **Ethernet LEDs** - The green LED indicates that a link has been established and the yellow LED indicates activity.
5. Go to [Initial Configuration](#) on Page 35 for default network settings and how to configure the DeviceMaster UP for use.



Configuring the DeviceMaster UP

The DeviceMaster UP platform includes PortVision DX, which is the management application that you use to manage all Control Ethernet-attached devices.

Note: *Existing installations: PortVision DX replaces PortVision Plus, you must install PortVision DX v3.02 or higher to upload the latest firmware.*

This section contains these topics:

- [PortVision DX Overview](#)
- [PortVision DX Requirements](#) on Page 12
- [Installing PortVision DX](#) on Page 12
- [Configuring the Network Settings](#) on Page 16
- [Checking the Protocol Firmware Version](#) on Page 19
- [Uploading Protocol-Specific Firmware on the DeviceMaster UP](#) on Page 20
- [Customizing PortVision DX](#) on Page 22
- [Accessing DeviceMaster UP Documentation from PortVision DX](#) on Page 23

Note: *If PortVision DX is already installed, go directly to [Configuring the Network Settings](#) on Page 16 to change the IP address on the DeviceMaster UP.*

PortVision DX Overview

PortVision DX automatically detects Control Ethernet-attached products physically attached to the local network segment so that you can configure the network address, upload firmware, and manage the following products:

- DeviceMaster family
 - DeviceMaster PRO
 - DeviceMaster RTS
 - DeviceMaster Serial Hub
 - DeviceMaster UP
 - DeviceMaster 500
- DeviceMaster LT
- IO-Link Master
- RocketLinx switches

In addition to identifying Control Ethernet-attached products, you can use PortVision DX to display any third-party switch and hardware that may be connected directly to those devices. All non-Control products and unmanaged RocketLinx switches are treated as non-intelligent devices and have limited feature support. For example, you cannot configure or update firmware on a third-party switch.

PortVision DX Requirements

Use PortVision DX to identify, configure, update, and manage the DeviceMaster UP on the following Windows operating systems:

- Windows 8/8.1
- Windows Server 2012
- Windows 7
- Windows Server 2008
- Windows Vista
- Windows Server 2003
- Windows XP

PortVision DX requires that you connect the Control Ethernet-attached product to the same network segment as the Windows host system if you want to be able to scan and locate it automatically during the configuration process.

Before installing PortVision DX, consider the following:

- Use PortVision DX to upload firmware and apply changes to a DeviceMaster UP that is on the same local network segment as the system on which PortVision DX is installed. You cannot apply changes through PortVision DX to a DeviceMaster UP that is not on the same local network segment.
- Use PortVision DX to monitor any DeviceMaster UP on the network. The DeviceMaster UP does not have to be on the same local network segment as PortVision DX for monitoring purposes.

Installing PortVision DX

During initial configuration, PortVision DX automatically detects and identifies DeviceMaster UP units, if they are in the same network segment.

Use the *Software and Documentation* CD that came with the DeviceMaster UP to check for the latest version of PortVision DX or use the link below to download the latest version.

1. Locate PortVision DX using one of the following methods to download the latest version:
 - **Software and Documentation CD:** You can use the CD menu system to check the version on the CD against the latest released version.
 - **FTP site subdirectory:**
ftp://ftp.control.com/dev_mstr/portvision_dx.

Note: Depending on your operating system, you may need to respond to a Security Warning to permit access.

2. Execute the `PortVision_DX[version].msi` file.

3. Click **Next** on the *Welcome* screen.



4. Click **I accept the terms in the License Agreement** and **Next**.

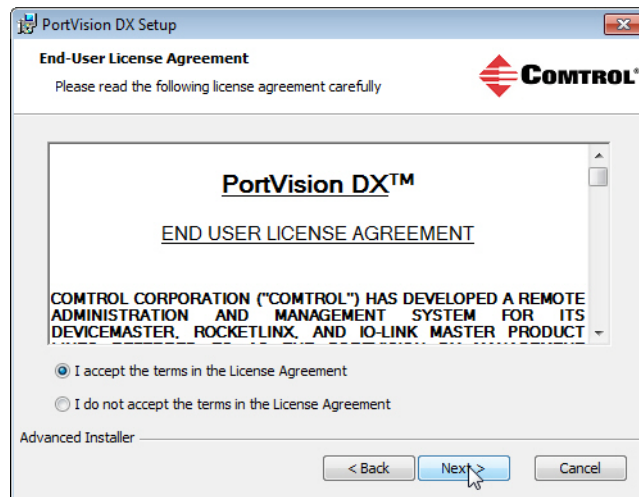

5. Click **Next** or optionally, browse to a different location and then click **Next**.

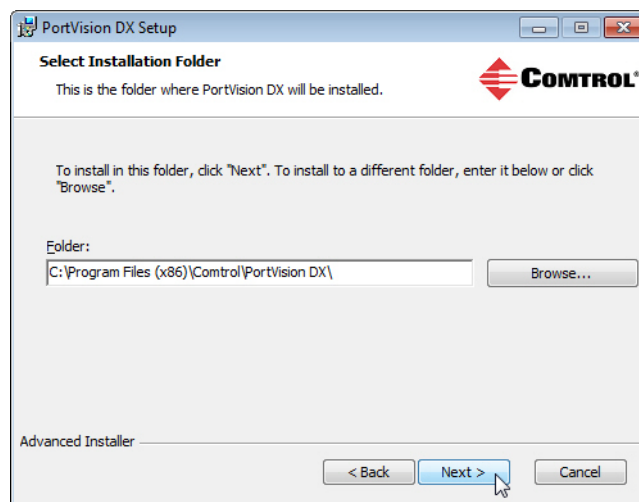

6. Click **Next** to configure the shortcuts.

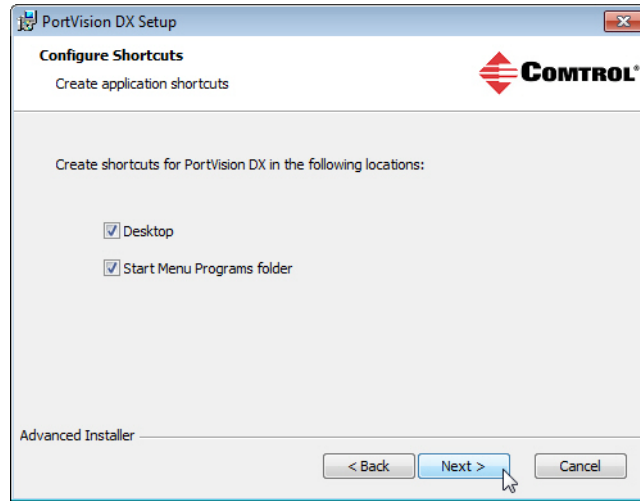

7. Click **Install**.

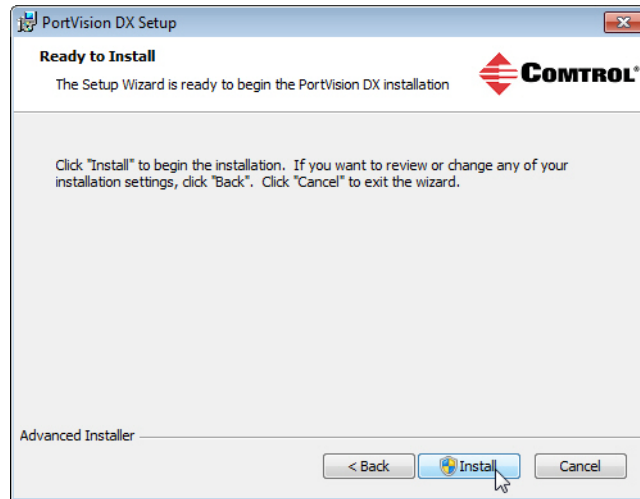

8. Depending on the operating system, you may need to click **Yes** to the *Do you want to allow the following program to install software on this computer?* query.

- Click **Launch PortVision DX** and **Finish** in the last installation screen.

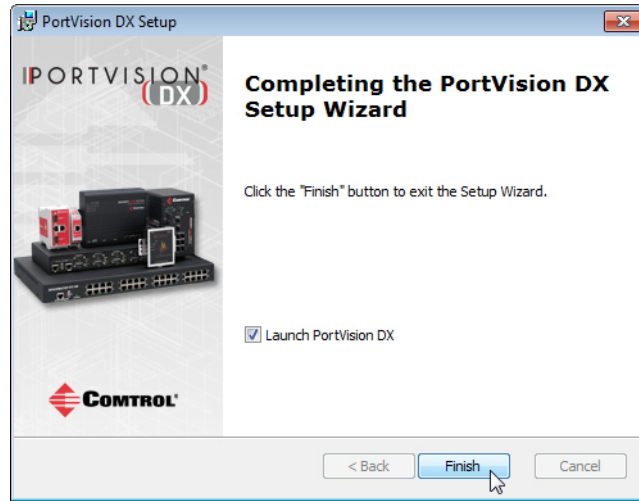

- Depending on the operating system, you may need to click **Yes** to the *Do you want to allow the following program to make changes to this computer?* query.
- Select the Control Ethernet-attached products that you want to locate and then click **Scan**.

You can save time if you only scan for DeviceMaster

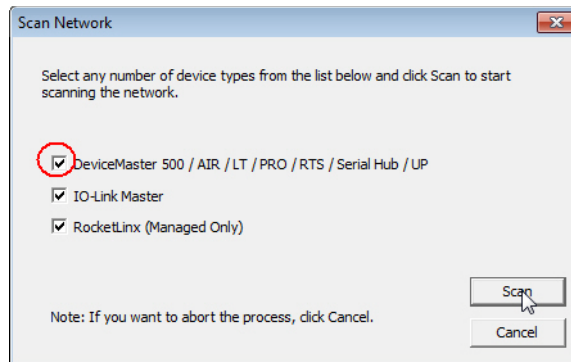

Note: *If the Control Ethernet-attached product is not on the local segment and it has been programmed with an IP address, it will be necessary to manually add the Control Ethernet-attached product to PortVision DX.*

- Go to [Step 5](#) in the next section, *Configuring the Network Settings*, to program the DeviceMaster UP network settings.

If you need additional information about PortVision DX, refer to the **Help** system.

Configuring the Network Settings

Use the following procedure to change the default network settings on the DeviceMaster UP for your network.

Default Network Settings

IP address:
192.168.250.250

Subnet mask:
255.255.0.0

Gateway address:
192.168.250.1

Note: *Technical Support advises configuring one new DeviceMaster UP at a time to avoid device driver configuration problems. If you want to configure multiple DeviceMaster UPs using the **Assign IP to Multiple Devices** option, see [Configuring Multiple DeviceMaster UPs Network Addresses](#) on Page 31.*

The following procedure shows how to configure a single DeviceMaster UP connected to the same network segment as the Windows system. If the DeviceMaster UP is not on the same physical segment, you can add it manually using [Adding a New Device in PortVision DX](#) on Page 31.

1. If you have not done so, install PortVision DX ([Installing PortVision DX](#) on Page 12).
2. Start PortVision DX using the **PortVision DX** desktop shortcut or from the **Start** button, click **Programs > Control > PortVision DX > PortVision DX**.
3. Depending on your operating system, you may need to click **Yes** to the *Do you want to allow the following program to make changes to this computer?* query.
4. Click **Scan** to locate the Control Ethernet-attached products including the DeviceMaster UP on the network.

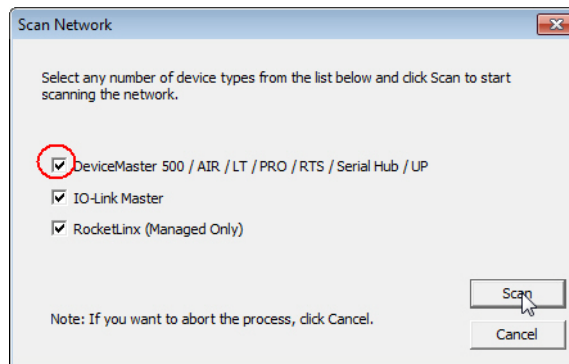

Note: *If you do not have any RocketLinx managed switches or IO-Link Masters, it saves scanning time if you do not scan for them.*

5. Highlight the DeviceMaster UP for which you want to program network information and open the **Properties** screen using one of these methods.
 - Double-click the DeviceMaster UP in the *Device Tree* or *Device List* pane.
 - Right-click the DeviceMaster UP in the *Device Tree* or *Device List* pane and click **Properties** in the popup menu
 - Highlight the DeviceMaster UP in the *Device Tree* or *Device List* pane and click the **Properties** button.
 - Highlight the DeviceMaster UP, click the **Manage** menu and then **Properties**.

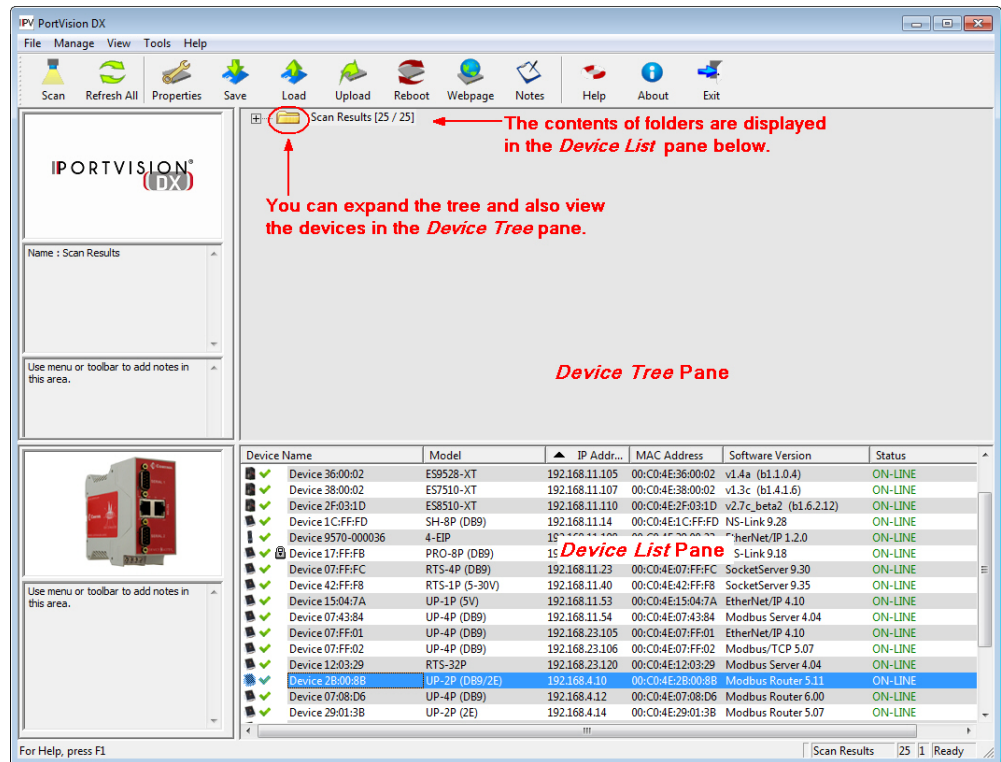

6. *Optionally*, rename the DeviceMaster UP in the **Device Name** field.

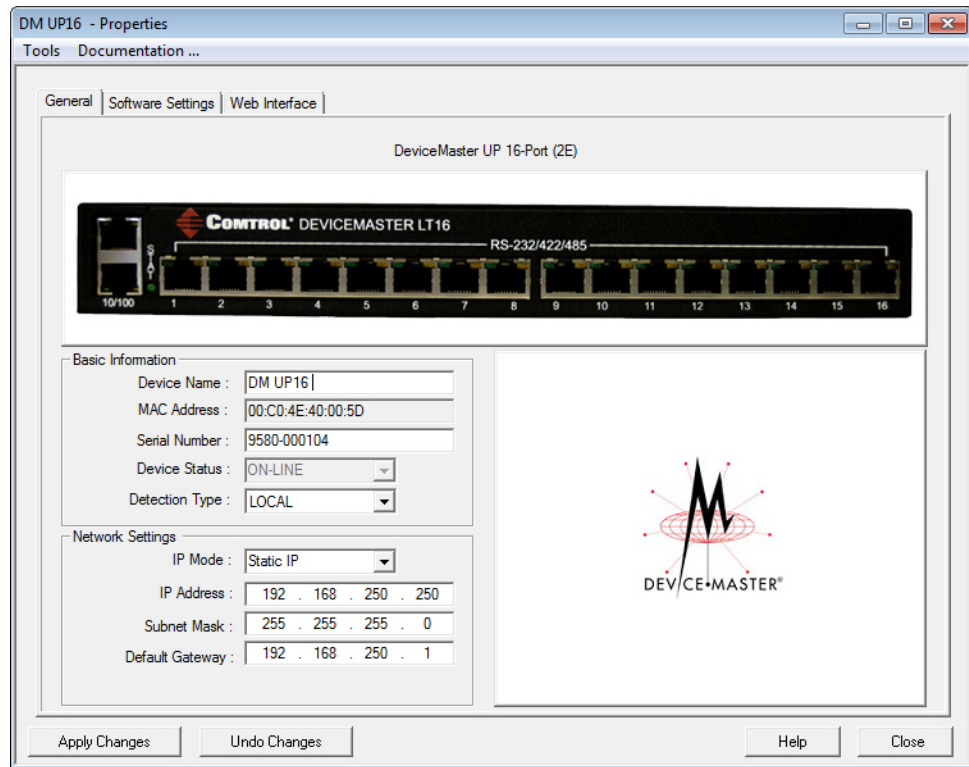

Note: The MAC address Device Status fields are automatically populated and you cannot change those values.

7. *Optionally*, enter the serial number, which is on a label on the DeviceMaster UP.
8. If necessary, you can change the **Detection Type**.
 - **REMOTE** means that the DeviceMaster UP is not connected to this segment of the network and it uses IP communications, not MAC communications.
 - **LOCAL** means that the DeviceMaster UP is on this local network segment and uses MAC communications. An IP address is not required but Technical support recommends using an IP address.
9. Change the DeviceMaster UP network properties as required for your site.

Disable IP	Do not use this option. The DeviceMaster UP does not support using the MAC addressing scheme.
DHCP IP†	Click this option if you want to use the DeviceMaster UP with DHCP. Make sure that you provide the MAC address of the DeviceMaster UP to the network administrator.
Static IP†	Click this option to program a static IP address and type the appropriate IP address, subnet mask, and default gateway values for your site in the provided boxes.

Note: For additional information, open the PortVision DX Help system.

10. Click **Apply Changes** to update the network information on the DeviceMaster UP.

Note: If you are deploying multiple DeviceMaster UPs that share common values, you can save the configuration file and load that configuration onto other DeviceMaster UPs using the **Software Settings** tab. See [Using Configuration Files](#) on Page 33 for more information.

11. Click **Close** to exit the *Properties* window.
12. If applicable, check your firmware version to make sure that it is the latest version using the next subsection, [Checking the Protocol Firmware Version](#).
13. If necessary, use [Uploading Protocol-Specific Firmware on the DeviceMaster UP](#) on Page 20 to update or load the firmware for your DeviceMaster UP.

Checking the Protocol Firmware Version

Use PortVision DX to check the firmware version before configuring the ports. Depending on the model you purchased, the DeviceMaster UP may or may not have the protocol firmware loaded.

Note: Models that have a protocol loaded on the DeviceMaster UP are identified in PortVision DX and the DeviceMaster UP is labeled accordingly.

The following procedure shows how to use PortVision DX to check the firmware version on the DeviceMaster UP and check for the latest files.

Note: If you have not done so, install PortVision DX ([Installing PortVision DX](#) on Page 12).

1. Start PortVision DX by double-clicking the PortVision DX desktop icon or click **Start > Programs > Control > PortVision DX > PortVision DX**.
2. Examine the *List View* pane to see if or/and what version of the firmware is loaded on the DeviceMaster UP. If you see SocketServer or NS-Link as the *Software Version*, you must load the appropriate firmware for your protocol.

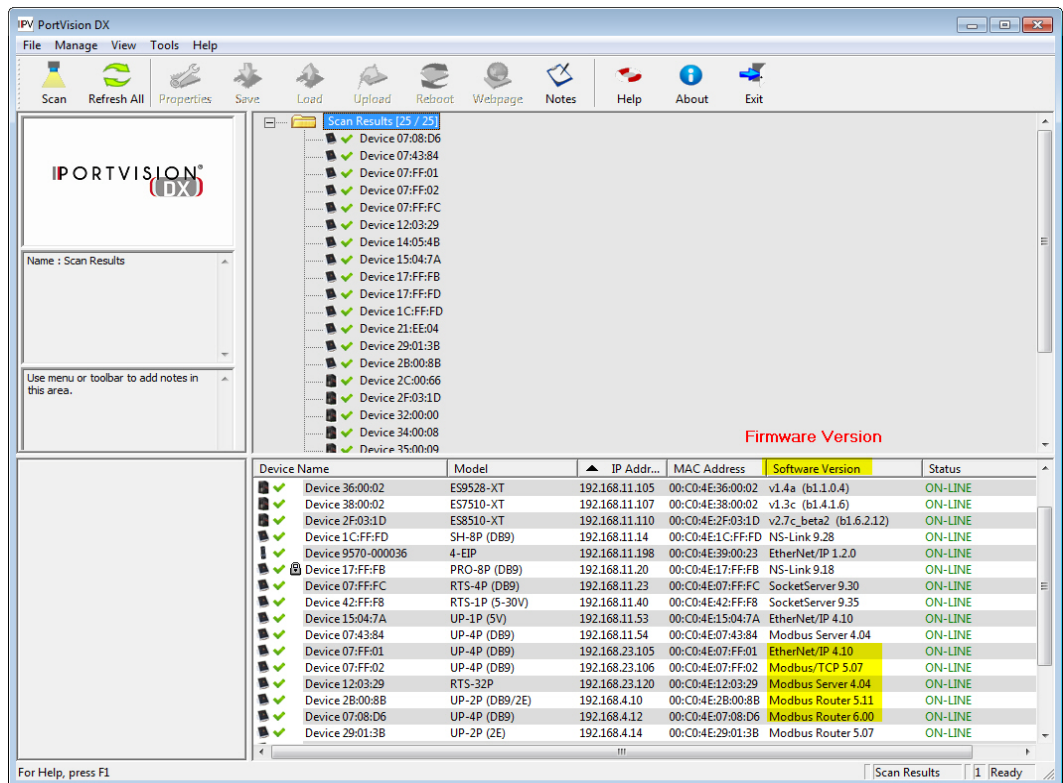

3. Check the Control FTP site to see if there is a later version available at: ftp://ftp.comtrol.com/dev_mstr/up/software/modbus_router/firmware.
4. If applicable, download the latest version and go to [Step 2](#) in [Uploading Protocol-Specific Firmware on the DeviceMaster UP](#) on Page 20.

Uploading Protocol-Specific Firmware on the DeviceMaster UP

Some DeviceMaster UP models come from the factory with SocketServer firmware, which provides an interface to TCP/IP socket mode configuration and services, installed on the device.

If your DeviceMaster UP contains SocketServer, you must replace SocketServer with Modbus Router.

The CD shipped with the DeviceMaster UP contains the required firmware and support files in a self-installing (.msi) file or you can download the latest from the Internet.

Use the following procedure to update the firmware on your DeviceMaster UP for Modbus Router. See [Locating Software and Documentation](#) on Page 6, if you need to download the .msi file.

Note: If you have not done so, install PortVision DX ([Installing PortVision DX](#) on Page 12) and install the firmware.msi file.

1. Start PortVision DX by double-clicking the PortVision DX desktop icon or click **Start > Programs > Control > PortVision DX > PortVision DX**.
2. Right-click the device or devices for which you want to upload firmware and click the **Advanced > Upload Firmware** menu option.

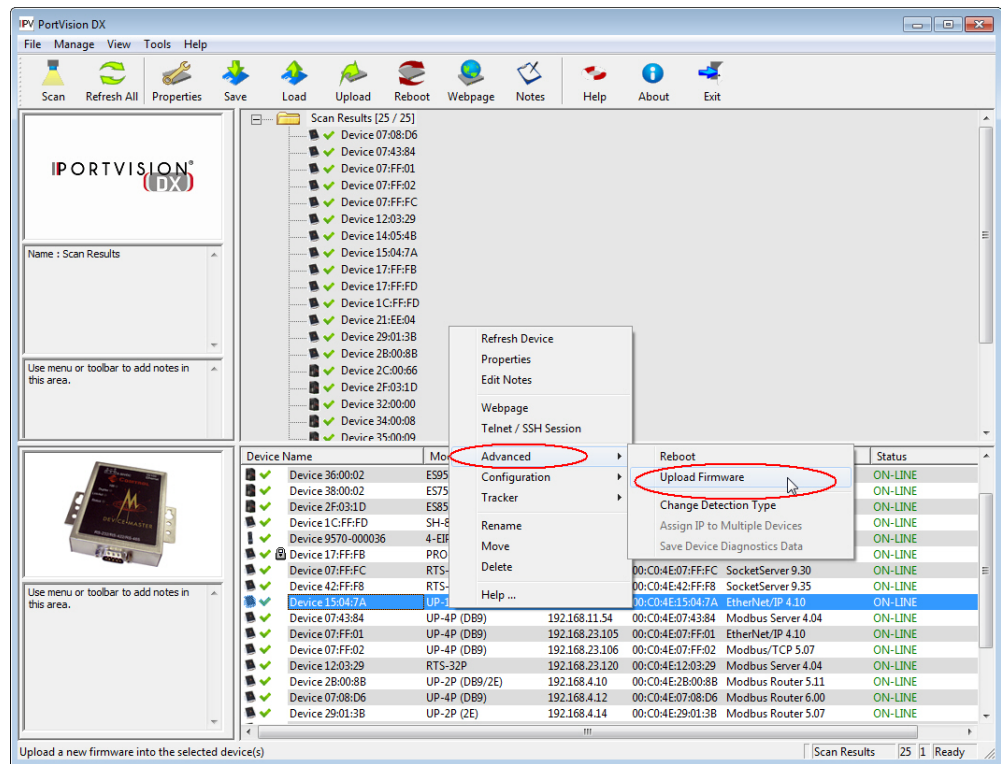

Note: Optionally, you can highlight a device and use the **Load** button.

3. Browse and select the protocol firmware (.cmtl) file and click **Open**.

- Click **Yes** to upload the firmware.

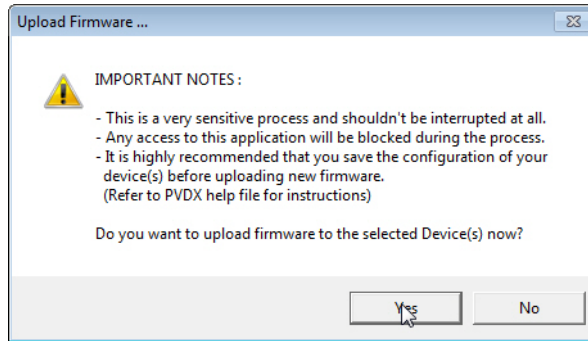

- Click **OK** to the advisory message about waiting until the DeviceMaster UP is on-line and in the next minute the DeviceMaster UP unit or units should display **ON-LINE** in the **Status** field.

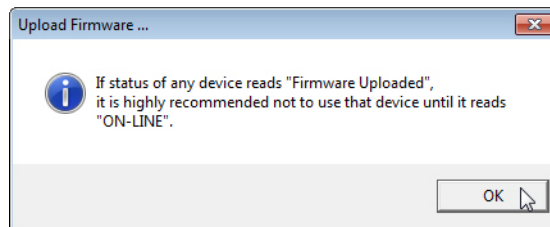

- Go to the *DeviceMaster UP Modbus Router User Guide* for information about configuring the serial port or ports using the web page and programming your PLCs. See [Locating Software and Documentation](#) on Page 6 to locate the document or refer to the installation CD shipped with the DeviceMaster UP.

If you are planning on installing multiple DeviceMaster UPs, you may want to use the *Save/Load Configuration File* feature in PortVision DX.

A configuration file can contain network settings and protocol settings. Refer to the PortVision DX help system for information about saving and loading configuration files.

- After configuring the serial port characteristics and preparing your PLC programs, you can use the next section in this guide, to attach the serial device or devices.

Customizing PortVision DX

You can customize how PortVision DX displays the devices. You can even create sessions tailored for specific audiences. You can also add shortcuts to other applications using **Tools > Applications > Customize** feature.

The following illustrates how you can customize your view.

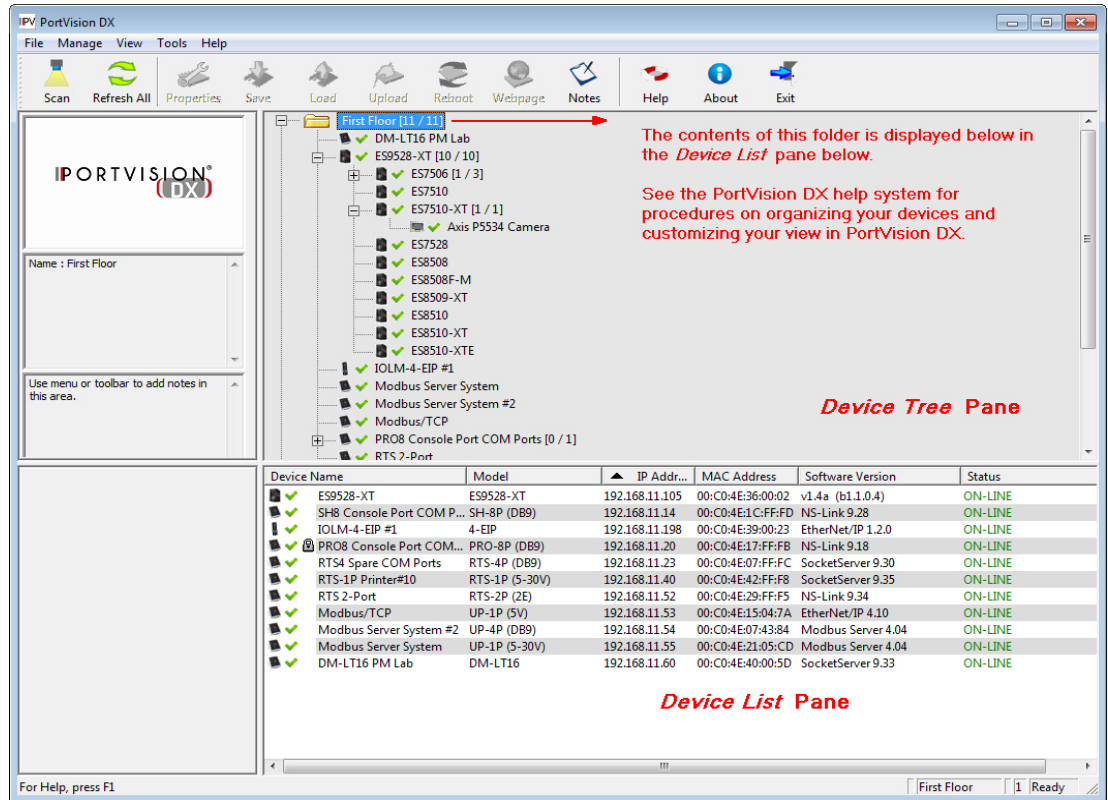

See the PortVision DX Help system for detailed information about modifying the view. For example, the above screen shot illustrates devices layered in folders.

Accessing DeviceMaster UP Documentation from PortVision DX

You can use this procedure in PortVision DX to [download](#) and [open the previously downloaded documents](#) for the DeviceMaster UP. You can also check to see if you have the latest version of the documentation using PortVision DX.

How to Download Documentation

Use this procedure to initially download a document or documents.

1. If necessary, open **PortVision DX > Start/Programs > Control > PortVision DX > PortVision DX** or use the desktop shortcut.
2. Click **Help > Documentation**.
3. Optionally, click the **DOWNLOAD THE CURRENT DOCUMENTATION CATALOG ONLINE** button to make sure that the latest documentation is available to PortVision DX.

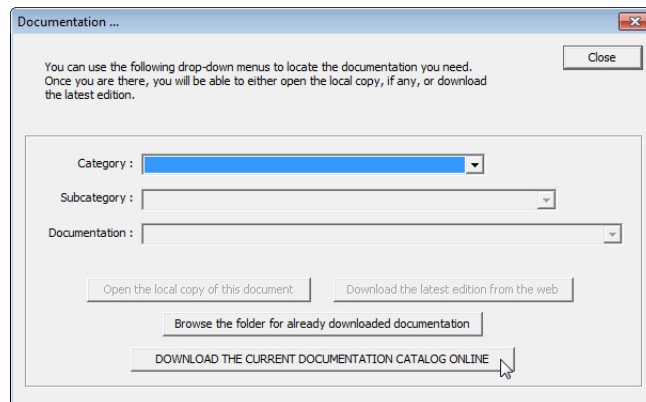
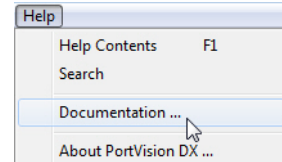

4. Select the product **Category** from the drop list.
5. Select the document you want to download from the **Documentation** drop list.
6. Click the **Download the latest edition from the web** button.

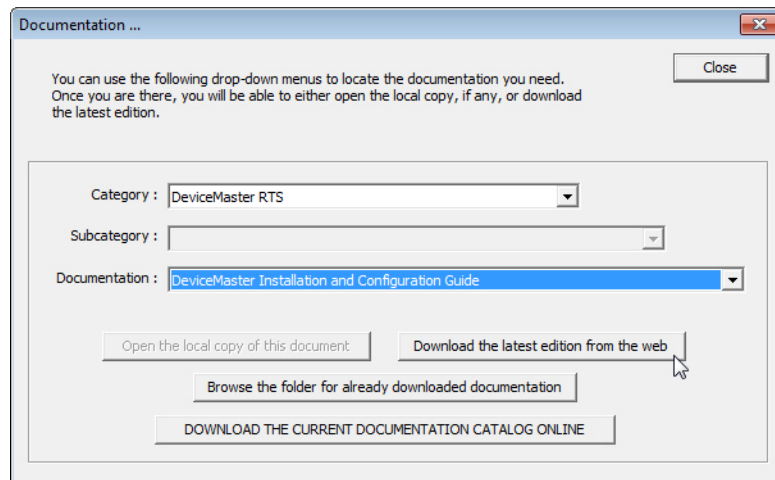

Note: It may take a few minutes to download, depending on your connection speed. The document opens automatically after it has downloaded.

7. Click **Close** if you have downloaded all of the documents that you wanted.

How to Open Previously Downloaded Documents

Use the following procedure to access previously downloaded documents in PortVision DX.

Note: *Optionally, you can browse to the **Program Files (x86) > Control > PortVision DX > Docs** subdirectory and open the document.*

1. If necessary, open **PortVision DX > Start/Programs > Control > PortVision DX > PortVision DX** or use the desktop shortcut.
2. Click **Help > Documentation**.
3. Click the **Open the local copy of the document** button to view the document.

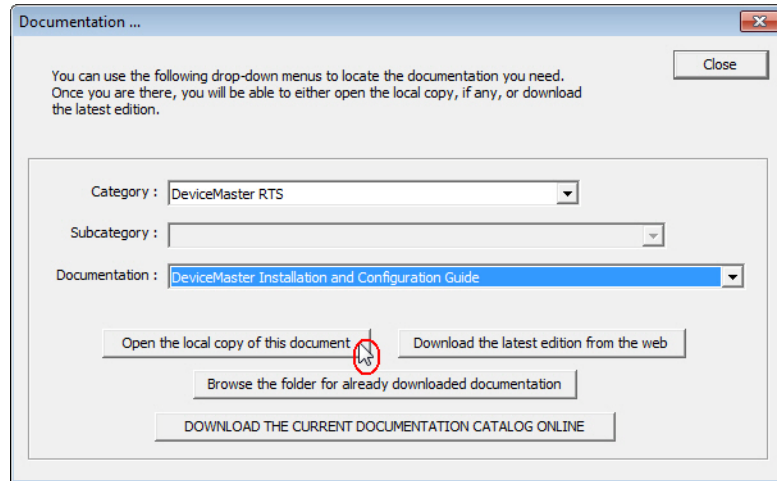

Note: *If the document fails to open, it may be that your browser has been disabled. You can still access the document by clicking the **Browse the folder for already downloaded documentation** button and opening the document with your custom browser.*

4. Click **Close** in the *Documentation...* popup, unless you want to open or download other documents.

Connecting Serial Devices

Note: If you have a DeviceMaster UP with 1, 2, or 4-ports, use the [DeviceMaster UP Hardware Installation and Configuration Guide](#) because the RJ45 connectors have different pin outs.

This section discusses connecting your serial devices to the DeviceMaster UP. It also provides you with information to build serial cables and loopback connectors to test the serial ports.

Use the appropriate subsection to connect asynchronous serial devices to the DeviceMaster UP ports.

This subsection provides the following information:

- Connector pin assignments (below)
- [RJ45 Null-Modem Cables \(RS-232\)](#) on Page 26
- [RJ45 Null-Modem Cables \(RS-422\)](#) on Page 26
- [RJ45 Straight-Through Cables \(RS-232/485\)](#) on Page 26
- [RJ45 Loopback Plugs](#) on Page 27
- [RJ45 RS-485 Test Cable](#) on Page 27
- [Connecting RJ45 Devices](#) on Page 27

You can build your own null-modem or straight-through RJ45 serial cables if you are using the DB9 to RJ45 adapters using the following subsections.

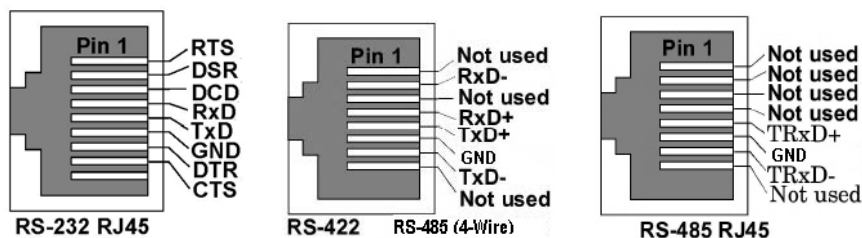

Pin	RS-232	RS-422 RS-485 (4-Wire)	RS-485 (2-Wire)
1	RTS	Not used	Not used
2	DSR	RxD-	Not used
3	DCD	Not used	Not used
4	RxD	RxD+	Not used
5	TxD	TxD+	TxD/RxD+
6	GND	GND	GND
7	DTR	TxD-	TxD/RxD-
8	CTS	Not used	Not used

RJ45 Null-Modem Cables (RS-232)

Use the following figure if you need to build an RS-232 null-modem cable. A null-modem cable is required for connecting DTE devices.

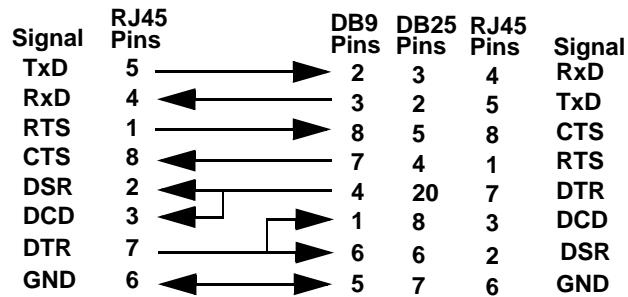

Note: You may want to purchase or build a straight-through cable and purchase a null-modem adapter. For example, a null-modem cable can be used to connect COM2 of one PC to COM2 of another PC.

RJ45 Null-Modem Cables (RS-422)

Use the following figure if you need to build an RS-422 null-modem RJ45 cable. A null-modem cable is required for connecting DTE devices.

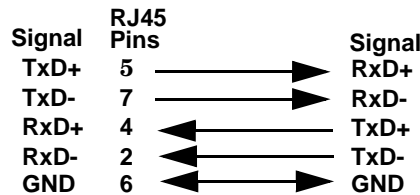

Note: RS-422 pinouts are not standardized. Each peripheral manufacturer uses different pinouts. Please refer to the documentation for the peripheral to determine the pinouts for the signals above.

RJ45 Straight-Through Cables (RS-232/485)

Use the following figure if you need to build an RS-232 or RS-485 straight-through cable. Straight-through cables are used to connect modems and other DCE devices. For example, a straight-through cable can be used to connect COM2 of one PC to COM2 to a modem.

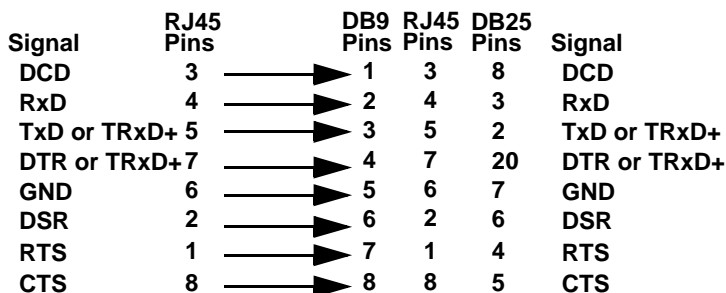

RJ45 Loopback Plugs

Loopback connectors are RJ45 serial port plugs with pins wired together that are used in conjunction with application software (Test Terminal for Windows, which is available in PortVision DX or Minicom for Linux) to test serial ports. The DeviceMaster UP is shipped with a single loopback plug (RS-232/422).

- Pins 4 to 5
- Pins 1 to 8
- Pins 2 to 3 to 7

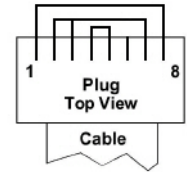

The RS-232 loopback plug also works for RS-422.

RJ45 RS-485 Test Cable

You can use a straight-through cable as illustrated previously, or build your own cable.

Note: *RS-422 pinouts are not standardized. Each peripheral manufacturer uses different pinouts. Refer to the documentation for the peripheral to determine the pinouts for the signals above.*

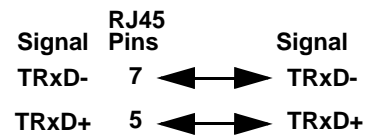

Connecting RJ45 Devices

You can use this information to connect serial devices to RJ45 connectors.

1. Connect your serial devices to the appropriate serial port on the DeviceMaster UP using the appropriate cable.

Note: *Refer to the hardware manufacturer's installation documentation if you need help with connector pinouts or cabling for the peripheral device.*

2. Verify that the DeviceMaster UP LEDs indicate that the devices are communicating properly.

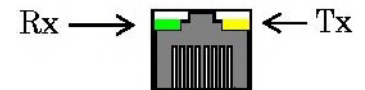

The LED functions are displayed in the following table when the cable is attached properly to a serial device.

LED	Mode	Description	LED Status
RX (Green)	RS-232	No valid RS-232 device is connected	Always off
		Valid RS-232 device is connected but no data transmission is occurring	On
		Data being received	LED blinks
	RS-422/485	No data being received	Always off
		Data being received	LED blinks
		No mode	No mode selected
TX (Yellow)	RS-232/ 422/485	No data being transmitted	Always off
		Data being transmitted	LED blinks

3. You can refer to [DeviceMaster UP LEDs](#) on Page 53 for information about the remaining LEDs.

Note: *The RX/TX LEDs cycle during a reboot cycle.*

Managing the DeviceMaster UP

This section discusses the following DeviceMaster UP maintenance procedures:

- [Rebooting the DeviceMaster UP](#)
- [Uploading Firmware to Multiple DeviceMaster UPs](#) on Page 30
- [Configuring Multiple DeviceMaster UPs Network Addresses](#) on Page 31
Note: You can configure the network addresses for multiple DeviceMaster UPs, configure common settings for the DeviceMaster UPs, and save the settings to a configuration file that you can use to load settings up to all or selected DeviceMaster UPs.
- [Adding a New Device in PortVision DX](#) on Page 31
- [Using Configuration Files](#) on Page 33
- [Managing Bootloader](#) on Page 35, which also discusses checking the Bootloader version and downloading the latest Bootloader
- [Accessing RedBoot Commands in Telnet/SSH Sessions \(PortVision DX\)](#) on Page 37

Note: You can optionally refer to [RedBoot Procedures](#) on Page 41 if you want to perform procedures at the RedBoot level.

Rebooting the DeviceMaster UP

There are many ways to reboot the DeviceMaster UP.

Method	Procedure
PortVision DX	Right-click the DeviceMaster UP or DeviceMaster UPs in the <i>Device List</i> pane, click Advanced >Reboot and then Yes . Note: If security has been enabled in the web page, you will need to reboot the DeviceMaster UP in the web page.
Web page	<i>Main page (Server Status):</i> Scroll to the bottom of the page, click Reboot and then Yes: Reboot .
Telnet	Type reset .

Uploading Firmware to Multiple DeviceMaster UPs

You can use this procedure if your DeviceMaster UP is connected to the host PC, laptop, or if the DeviceMaster UP resides on the local network segment.

1. If you have not done so, install PortVision DX ([Installing PortVision DX](#) on Page 37) and Scan the network.
2. Shift-click the multiple DeviceMaster UPs on the **Main** screen that you want to update and use one of the following methods:
 - Click the **Upload** button.
 - Right-click and then click **Advanced > Upload Firmware**.
 - Click **Advanced > Upload Firmware** in the **Manage** menu.

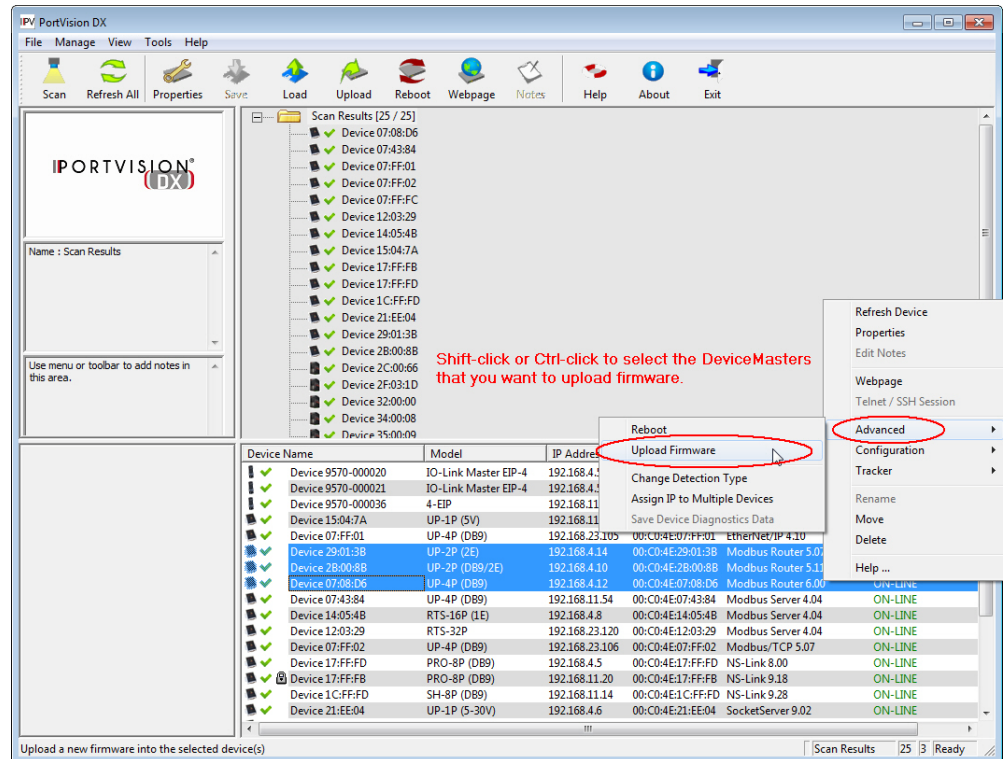

3. Browse, click the firmware (.cmtl) file, **Open** (*Please locate the new firmware*), and then click **Yes** (*Upload Firmware*).

It may take a few moments for the firmware to upload onto the DeviceMaster UP. The DeviceMaster UP reboots itself during the upload process.

4. Click **Ok** to the advisory message about waiting to use the device until the status reads **ON-LINE**.

In the next polling cycle, PortVision DX updates the *Device List* pane and displays the new firmware version.

Configuring Multiple DeviceMaster UPs Network Addresses

You can configure the network addresses for multiple DeviceMaster UPs using the **Assign IP to Multiple Devices** option.

In addition, you can also configure common settings for the DeviceMaster UP web page and save the settings to a configuration file that you can load to all or selected DeviceMaster UPs. See [Using Configuration Files](#) on Page 33 for more information.

The DeviceMaster UPs must be on the same network segment for this procedure to work. Use the following steps to configure multiple DeviceMaster UPs.

1. If you have not done so, install PortVision DX ([Installing PortVision DX](#) on Page 37) and **Scan** the network.
2. Shift-click the DeviceMaster UPs for which you want to program network information, right-click, and click **Advanced > Assign IP to Multiple Devices**.
3. Enter the starting IP address, subnet mask, IP Gateway and click **Proceed**.

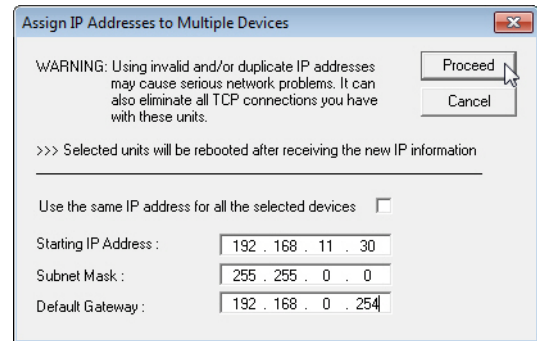

PortVision DX displays the programmed IP addresses in the *Device List* pane after the next refresh cycle.

Adding a New Device in PortVision DX

You can add a new DeviceMaster UP manually, if you do not want to scan the network to locate and add new DeviceMaster UPs, but there may be cases where you want to use the *Add New Device* window to:

- Configure DeviceMaster UP units that are not on the local network (remote) using [Remote Using the IP Address](#) on Page 31.
- Pre-configure a DeviceMaster UP in PortVision DX (local) using [Local Using the IP Address or MAC Address](#) on Page 32.

Remote Using the IP Address

Use the following procedure to add a remote DeviceMaster UP to PortVision DX.

1. Access the *New Device* window using one of these methods:
 - Click **Add New > Device** in the *Manage* menu.
 - Right-click a folder or a RocketLinux switch in the *Device Tree* pane (anywhere in the pane, as long as a DeviceMaster UP is not highlighted and you are in a valid folder) and click **Add New > Device**.
2. Select the appropriate DeviceMaster UP in the **Device Type** drop list.
3. Select the appropriate model in the **Device Model** drop list.
4. Enter a friendly device name in the **Device Name** list box.
5. Select **REMOTE** for the *Detection Type*.
6. Optionally, enter the serial number in the **Serial Number** list box.

7. Enter the IP Address for the DeviceMaster UP. It is not necessary to enter the Subnet Mask and Default Gateway.

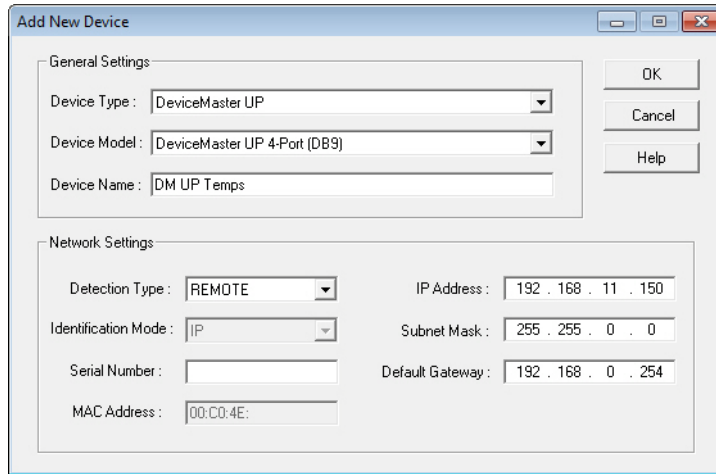

8. Click **Ok** to close the *Add New Device* window. It may take a few moments to save the DeviceMaster UP.
9. If necessary, click **Refresh** for the new DeviceMaster UP to display in the *Device Tree* or *Device List* panes. The DeviceMaster UP shows OFF-LINE if it is not attached to the network or if an incorrect IP address was entered.

Local Using the IP Address or MAC Address

Use the following procedure to add a local DeviceMaster UP to PortVision DX if you do not want to scan the network.

1. Locate the network information or MAC address of the DeviceMaster UP you want to add.
2. Access the *New Device* window using one of these methods:
 - Click **Add New > Device** in the *Manage* menu.
 - Right-click a folder or a RocketLinx switch in the *Device Tree* pane (anywhere in the pane, as long as a DeviceMaster UP is not highlighted and you are in a valid folder) and click **Add New > Device**.
3. Select the DeviceMaster UP in the **Device Type** drop list.

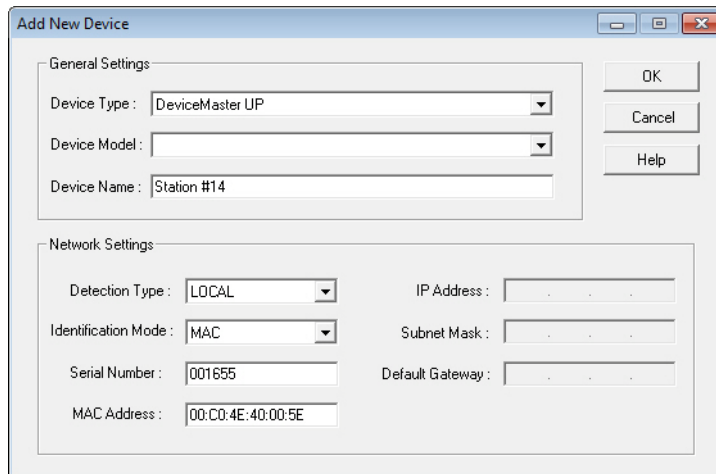

4. Select the appropriate model in the **Device Model** drop list.
5. Enter a friendly device name in the **Device Name** list box.

6. Select **LOCAL** for the *Detection Type*.
7. Enter the MAC address or network information.
Note: A MAC address label is attached to all DeviceMaster UP units. The first three pairs of digits start with 00 C0 4E.
8. Optionally, enter the serial number in the **Serial Number** list box.
9. Click **Ok**.
10. If necessary, click **Refresh** for the new DeviceMaster UP to display in the *Device Tree* or *Device List* panes. The DeviceMaster UP shows OFF-LINE if it is not attached to the network or if an incorrect IP address was entered.

Using Configuration Files

If you are deploying multiple DeviceMaster UP units that share common firmware values, you can save the configuration file (.dc) from the *Main* or **Properties > Software Settings** tab in PortVision DX and load that configuration onto other DeviceMaster UP units.

If you save a configuration file from the *Main* or **Software Settings** tab on the *Properties* screen, you can choose what settings you want saved or loaded.

You may want to program the network settings in multiple DeviceMaster UPs using [Configuring Multiple DeviceMaster UPs Network Addresses](#) on Page 31.

Saving a Configuration File

Use this procedure to save a configuration file using the *Main* screen.

Note: *Optionally, you can save a configuration file by accessing the **Software Settings** tab in the *Properties* screen and then clicking the **Save Settings to a File** button.*

1. If you have not done so, install PortVision DX ([Installing PortVision DX](#) on Page 37) and **Scan** the network.
2. Highlight the DeviceMaster UP in the *Device List* pane that you want to save its configuration and use one of the following methods:
 - Click the **Save** button.
 - Right-click and then click **Configuration > Save**.
3. Browse to the location you want to save the file, enter a file name, and click **Save**.
4. Click the **All** check box or click only the properties that you want saved for each property page in the configuration file and click **Done**.
5. Click **Ok** to close the *Save Configuration Completed* message.

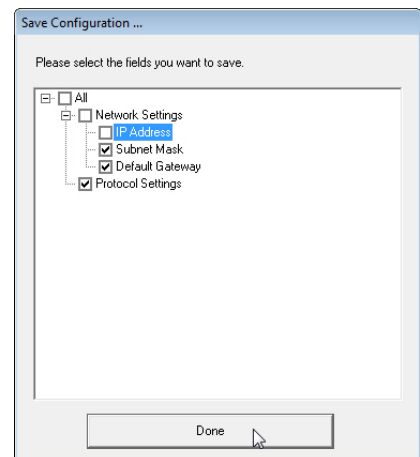

Loading a Configuration File

Use the following procedure to load a previously saved a DeviceMaster UP configuration file. Load a configuration file and apply it to a selected DeviceMaster UP or DeviceMaster UPs from the *Main* screen or the **Software Settings** tab on the *Properties* screen.

Use this procedure to load a configuration file using the *Device List* pane to one or more DeviceMaster UP units.

1. Highlight the device or devices in the *Device List* pane that you want to load and use one of the following methods:

- Click the **Load** button
- Right-click and then click **Configuration > Load**

2. Click **Yes** to the warning that it will take 25 seconds per device and it may also reboot the devices.
3. Browse to the location of the configuration file, click the file name (.dc) and then **Open**.
4. Click the **All** check box or click only the properties that you want to load for each property page in the configuration file and then click **Done**.

Note: *If you click All, every selected DeviceMaster UPs will be programmed with the same IP address.*

5. Close the *Load Configuration* popup message.

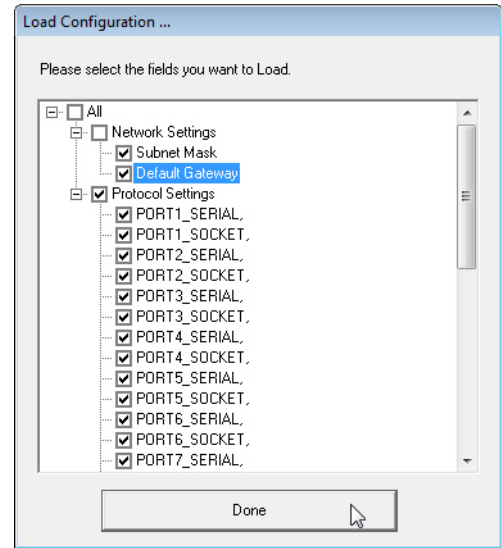

Managing Bootloader

Bootloader refers to the operating system that runs on the DeviceMaster UP hardware during the power on phase, which then loads the default application (for example, Modbus Router or EtherNet/IP firmware).

Note: Typically, you should not update the Bootloader unless advised to do so by Control Technical Support.

There are several methods and tools that you can use to check the Bootloader version or update the Bootloader.

- **PortVision DX** is the easiest way to check the Bootloader version and upload the latest version.
- Optionally, RedBoot can be used to check the Bootloader version and update the Bootloader. See [RedBoot Procedures](#) on Page 41 for procedures.

Checking the Bootloader Version

The following procedure uses PortVision DX to check the Bootloader version. Optionally, you can use RedBoot, see [Determining the Bootloader Version](#) on Page 45.

1. If you have not done so, install PortVision DX ([Installing PortVision DX](#) on Page 37) and **Scan** the network.
2. Right-click the DeviceMaster UP in the *Device List* pane and click **Advanced > Reboot**.
3. Click **Yes** to the *Confirm Reboot* query.
4. Right-click the DeviceMaster UP in the *Device List* pane, click **Refresh**. You may need to do this several times until you catch the reboot cycle in the *Device List* pane. The Bootloader version is briefly displayed during the reboot cycle before the application (for example, Modbus Router or EtherNet/IP firmware) loads.
5. Check the Control web site to see if [a later version](#) is available.
6. Go to the next subsection if you need upload a new version of Bootloader.

Uploading Bootloader

Use the following procedure to upload Bootloader to the DeviceMaster UP. Typically, you should not update the Bootloader unless advised to do so by Control Technical Support or a notice has been posted to the firmware download page on the ftp site.

Note: Technical Support does not recommend updating Bootloader across a WAN. For best results, connect the DeviceMaster UP directly to a PC or laptop to upload Bootloader.

Make sure that power is not interrupted while uploading Bootloader. Power interruption while uploading Bootloader will require that the DeviceMaster UP must be sent into Control so that it can be reflashed.

If you are not successful uploading firmware into the DeviceMaster UP, do not upload Bootloader.



Caution

1. If you have not done so, install PortVision DX ([Installing PortVision DX](#) on Page 37) and **Scan** the network.
2. If necessary, check the Bootloader version ([Checking the Bootloader Version](#)) and download the latest version.

- Right-click the DeviceMaster UP for which you want to update, click **Advanced > Upload Firmware**, browse to the Bootloader .cml file, and then click **Open**.

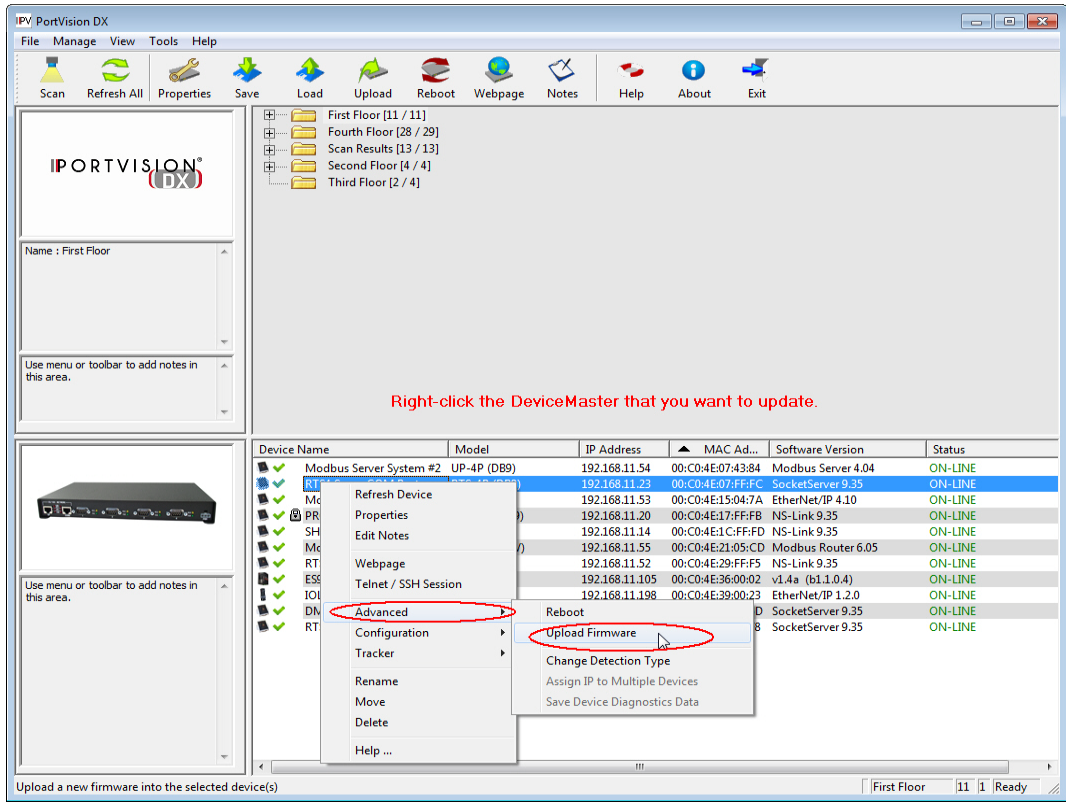

- Click **Yes** to the *Upload Firmware* message that warns you that this is a sensitive process.

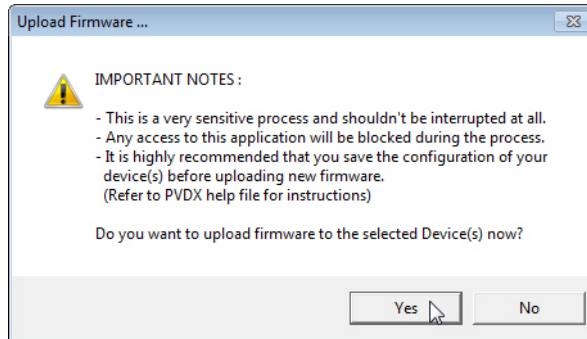

- Click **Ok** to the second *Upload Firmware* message.
- Right-click the DeviceMaster UP and click **Refresh** until the Bootloader version displays in the *Device List* pane and verify that the new version loaded.

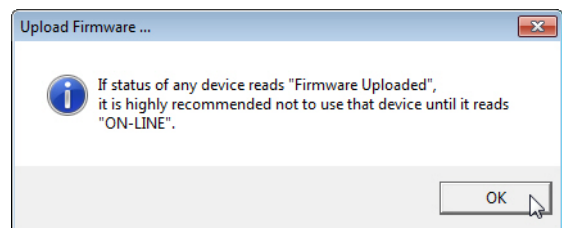

Accessing RedBoot Commands in Telnet/SSH Sessions (PortVision DX)

You can open a Telnet or SSH session using PortVision DX to access RedBoot commands.

Use the following procedure to access a telnet or SSH session with PortVision DX.

1. In PortVision DX, right-click the DeviceMaster UP in the *Device List* pane for which you want to open a telnet session, and click **Telnet/SSH Session**.

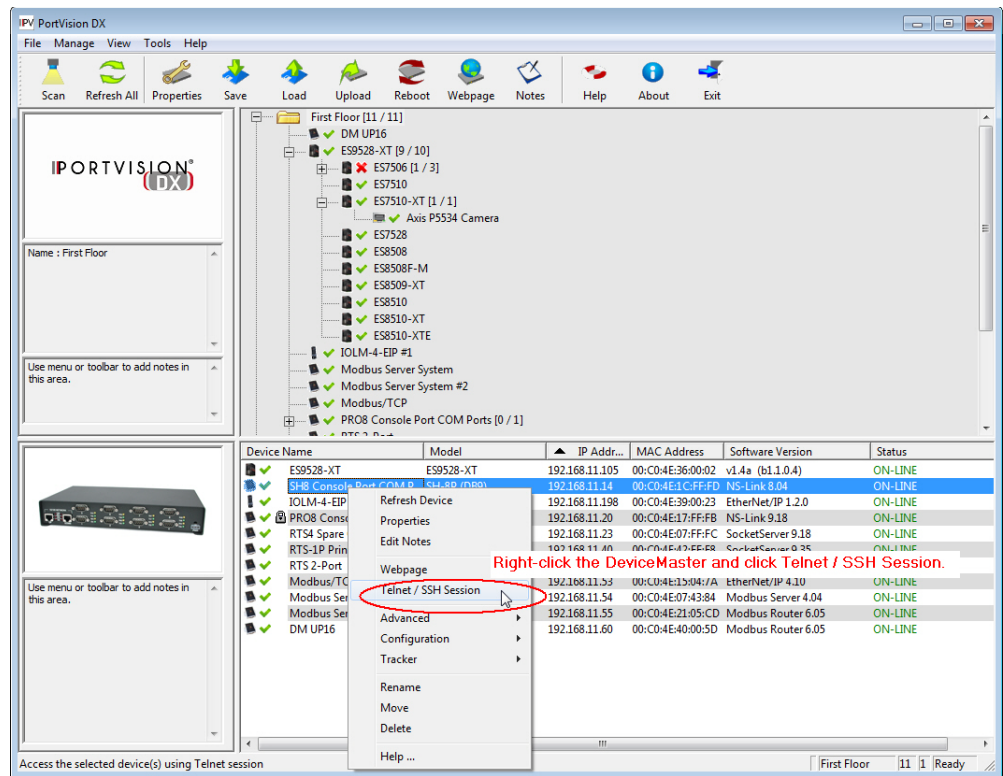

2. Select **Telnet** or **SSH**, leave the **Selected Port** number, and click **Ok**.

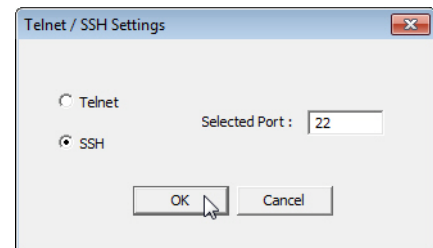
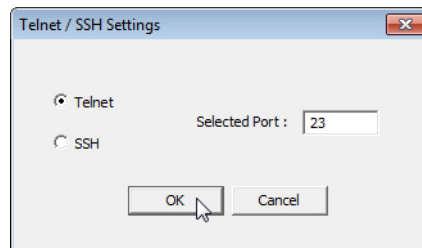

3. If necessary, enter the password and press **Enter**. If a password has not been set, press **Enter**. If using an SSH session, press **Enter** to the **login** as prompt.

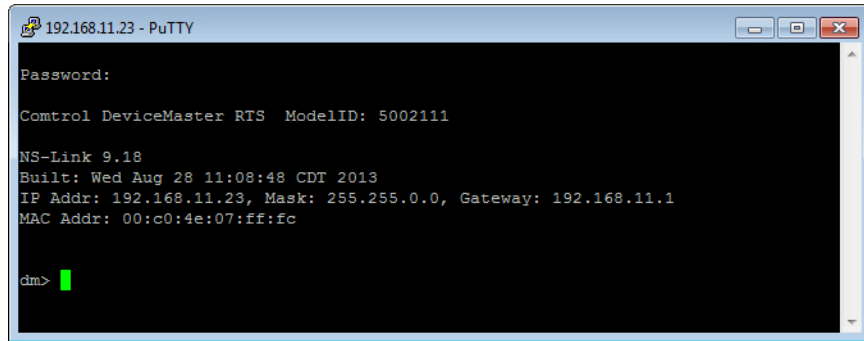

4. Type **Reset**, press **Enter**, and close the telnet session.

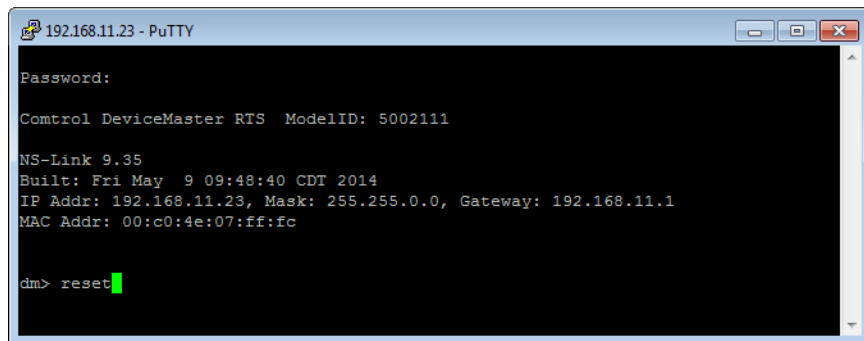

5. Quickly re-open the telnet or SSH session using the previous steps.

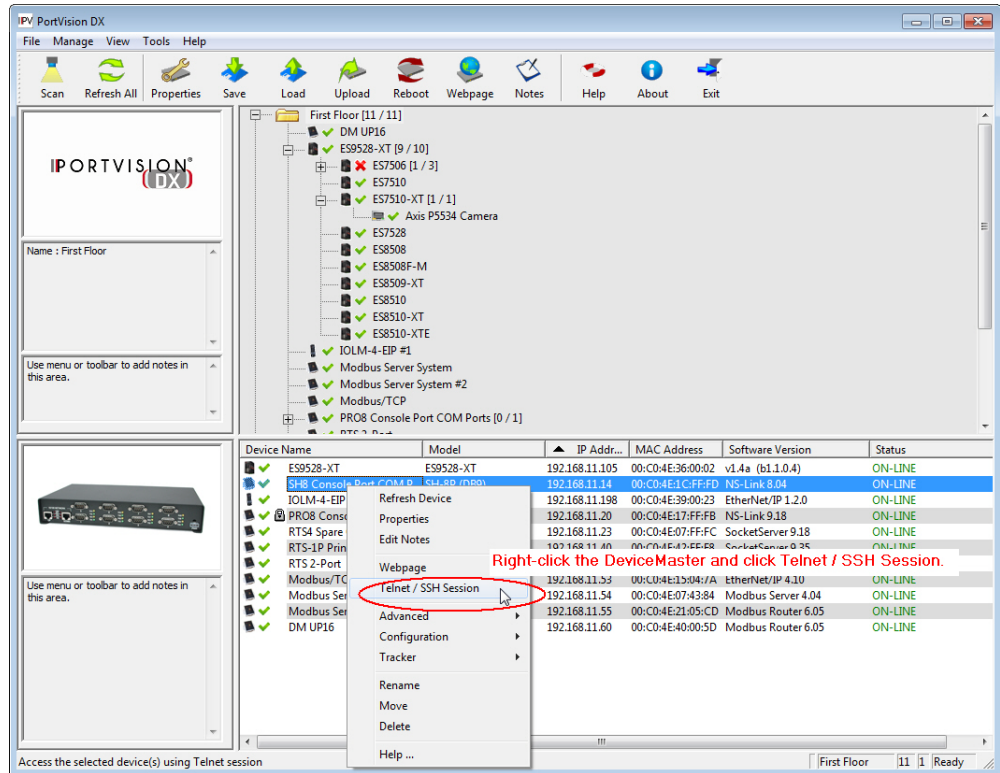

6. Select **Telnet** or **SSH**, leave the **Selected Port** number, and click **Ok**.

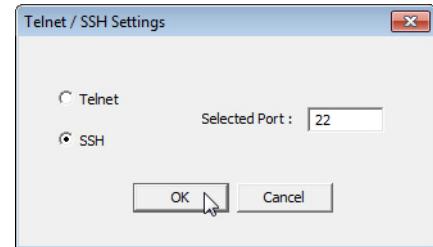
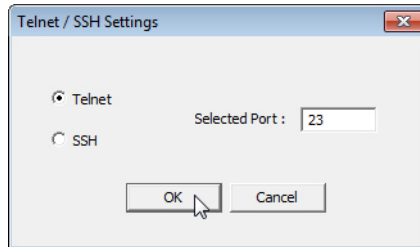

7. Press **Enter**. You can type **help** to review the RedBoot commands. You can also refer to [RedBoot Command Overview](#) on Page 47.

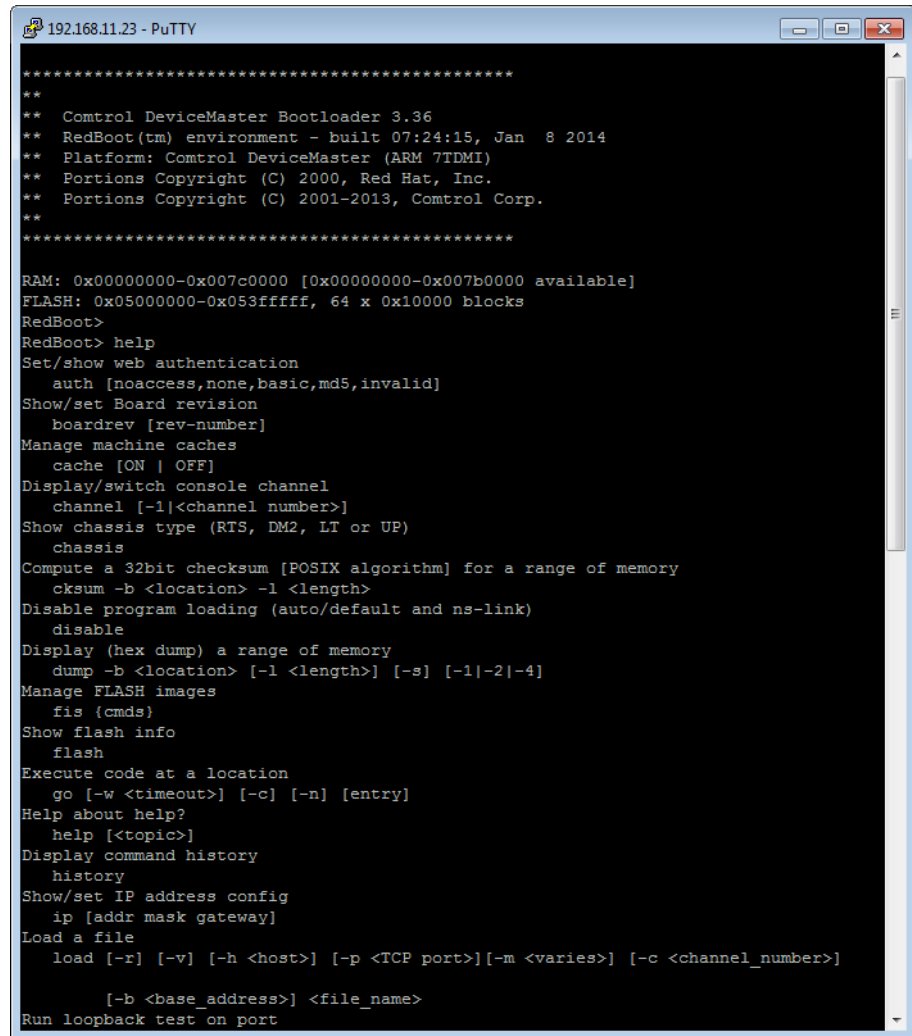

Note: The *dm* prompt should be replaced by a *redboot* prompt. If not, you can reset the Bootloader timeout for a longer time period and retry this procedure.

RedBoot Procedures

You can use this section as a reference if you want to perform tasks in RedBoot.

- [Accessing RedBoot Overview](#) on Page 41
- [Establishing a Serial Connection](#) on Page 42
- [Establishing a Telnet Connection](#) on Page 43
- [Determining the Network Settings](#) on Page 44
- [Configuring the Network Settings](#) on Page 44
- [Changing the Bootloader Timeout](#) Page 45
- [Determining the Bootloader Version](#) on Page 45
- [Resetting the DeviceMaster UP](#) on Page 46
- [Configuring Passwords](#) on Page 46
- [RedBoot Command Overview](#) on Page 47.

Optionally, you can install PortVision DX on a Windows system on the network and perform all of these tasks. PortVision DX provides a Telnet/SSH session, which is discussed in [Accessing RedBoot Commands in Telnet/SSH Sessions \(PortVision DX\)](#) on Page 37.

Accessing RedBoot Overview

To access RedBoot, you can use one of the following methods:

- A *serial* connection between Port 1 on the DeviceMaster UP and a COM port on a PC (Page 42). If you plan on using the serial method, you will need a null modem cable, a terminal program installed and configured on the PC, and a **Bootloader Timeout** value in excess of 15 seconds. If the **Bootloader Timeout** value has been reduced to 1 second, this procedure will NOT be possible.

Note: Use the serial connection method, if the DeviceMaster UP is not on the same Ethernet network segment as the PC.

If you do not know the IP address of the DeviceMaster UP you must use a serial connection to communicate with the DeviceMaster UP.

- A *telnet* connection (Page 43), if the DeviceMaster UP is locally accessible by Ethernet. A *telnet connection* requires that you know the IP address. In addition, the IP address must also be valid for the network to which it is attached.

For example: The network segment must be 192.168.250.x to telnet to the DeviceMaster UP default IP address if you have not changed the IP address to operate on your network.

Establishing a Serial Connection

Use the following procedure to set up a serial connection with a terminal server program. You can use HyperTerminal (Windows) or optionally, Test Terminal (WCom2), which can be accessed from PortVision DX using **Tools > Applications > Test Terminal (WCom2)**.

1. Connect a null-modem cable from an available COM port on your PC to **Port 1** on the DeviceMaster UP.

***Note:** See [Connecting Serial Devices](#) on Page 25, if you need to build a null-modem cable.*

2. Configure the terminal server program to the following values:

- Bits per second = 57600
- Data bits = 8
- Parity = None
- Stop bits = 1
- Flow control = None

***Note:** If you do not disable Bootloader from loading (Steps 3 through 5) within the time-out period (default is fifteen seconds), an application will be loaded from flash and started. If this happens, repeat Steps 3 through 5. The **#!DM** command is the only case-sensitive command and must be in uppercase.*

3. Reset the DeviceMaster UP.

***Note:** Depending on the model, disconnect and reconnect the power cable (external power supply and no power switch) or turn the power switch on and then off (internal power supply).*

4. Immediately type **#!DM** and press **Enter** in the terminal program.

```
#!DM
RedBoot>dis
Loading disabled
```

5. At the **RedBoot>** prompt, type **dis**, and press **Enter**.
6. Verify that loading has been disabled.
7. You can use the appropriate procedure listed on Page 41 or use the [RedBoot Command Overview](#) on Page 47 to perform the desired task.

Establishing a Telnet Connection

Use the following procedure to telnet to the DeviceMaster UP.

1. Open a telnet session, enter the DeviceMaster UP IP address.
If using Windows, you can use PortVision DX, see [Accessing RedBoot Commands in Telnet/SSH Sessions \(PortVision DX\)](#) on Page 37.
2. Press the **Enter** key if you did not program a password or type the password and press **Enter**.

```

♥♦
Password:

Comtrol DeviceMaster RTS Model ID: 5002111

SocketServer 9.35
Built: Fri May 09 09:48:40 CST 2014
IP Addr: 192.168.11.23, Mask: 255.255.0.0, Gateway: 192.168.0.254
MAC Addr: 00:c0:4e:07:ff:fc

dm> reset

```

Note: The DeviceMaster UP does not come pre-programmed with a password.

3. Type **reset**, and close the session.
4. Open a new telnet session, enter the DeviceMaster UP IP address, and the password.
5. Type **dis** to disable the Bootloader.

```

*****
**
** Control DeviceMaster Bootloader Version 3.36
** RedBoot(tm) environment - built 07:24:15, Jan 8 2014
** Platform: Comtrol DeviceMaster (ARM 7TDMI)
** Portions Copyright (C) 2000. Red Hat, Inc.
** Portions Copyright (C) 2001-2013 Comtrol Corp.
*****

RAM: 0x00000000-0x007c0000 (0x00000000 - 0x07b00000 available)
FLASH: 0x05000000 - 0x053fffff, 64 x 0x10000 blocks
RedBoot> dis
Loading disabled
RedBoot> _

```

6. Verify that the system responds with a **Loading disabled** message.

Determining the Network Settings

Default Network Settings

IP address:
192.168.250.250

Subnet mask:
255.255.0.0

Gateway address:
192.168.250.1

If you are not sure what the network information is on a DeviceMaster UP, you can perform the following procedure.

1. Establish communications with the DeviceMaster UP using the serial (Page 42) or telnet (Page 43) method.
2. At the **RedBoot** prompt, type **ip**.

```
RedBoot>dis
Loading disabled
RedBoot> ip
IP:      192.168.250.250
Mask:    255.255.0.0
Gateway: 192.168.50.1
RedBoot>
```

The IP address, subnet mask, and IP gateway values will display.

Note: *Optionally, you can install PortVision DX on a Windows system on the network and see the IP information in the Device List pane.*

Configuring the Network Settings

Use the following procedure to program the IP address using RedBoot.

1. Establish communications with the DeviceMaster UP using the serial (Page 42) or telnet (Page 43) method.
2. Enter **ip [addr mask gateway]** and press the **Enter** key to configure the IP address. *Where:*

addr = IP address you want to use

mask = matches you network subnet mask

gateway = assigned by your network administrator

Make sure that each value is separated by a space.

```
RedBoot>dis
Loading disabled
RedBoot> ip 192.168.11.152 255.255.0.0 192.168.0.254
RedBoot>
IP:      192.168.11.152
Mask:    255.255.0.0
Gateway: 192.168.0.254
RedBoot> reset
.. Resetting
```

3. Verify that RedBoot responds with your configured network information or reissue the command.
4. Type **reset** to reset the DeviceMaster UP, if you do not have any other related RedBoot tasks.

Changing the Bootloader Timeout

Use the following procedure to change the Bootloader timeout value.

1. Establish communications with the DeviceMaster UP using the serial (Page 42) or telnet (Page 43) method.
2. At the **RedBoot** prompt, type **timeout**.

```
RedBoot> dis
Loading disabled
RedBoot> timeout
Timeout 15 seconds
RedBoot> timeout 45
timeout 45 seconds
RedBoot>_
```

RedBoot responds with the current Bootloader timeout value.

3. Type **timeout** and a value to change the timeout value. For example, **timeout 45** to change the Bootloader timeout to 45 seconds.

Determining the Bootloader Version

Use the following procedure to determine what Bootloader version is loaded in the DeviceMaster UP.

1. Establish communications with the DeviceMaster UP using the serial (Page 42) or telnet (Page 43) method.
2. At the **RedBoot** prompt, type **version**.

```
RedBoot> ver
*****
**
** Control DeviceMaster Bootloader Version 3.23
** RedBoot(tm) environment - built 14:59:20, Oct 13 2011
** Platform: Comtrol DeviceMaster (ARM 7TDMI)
** Portions Copyright (C) 2000. Red Hat, Inc.
** Portions Copyright (C) 2001-2008 Comtrol Corp.
*****

FLASH: 64 blocks of 65536 bytes each
FLASH: 4194304 bytes (0x05000000 - 0x05400000)
RAM: 8126464 bytes (0x00000000 - 0x007c0000)
RedBoot>
```

The Bootloader information displays.

3. Type **reset** to reset the DeviceMaster UP, if you do not have any other related RedBoot tasks.

Note: *Optionally, you can install PortVision DX on a Windows system on the network and see the Bootloader version in the Device List pane. Reboot the DeviceMaster UP, right-click the DeviceMaster UP and click Refresh Device until the Bootloader version displays. The Bootloader version is only displayed for a few moments.*

Resetting the DeviceMaster UP

When you have completed your tasks in RedBoot, you must enter a **reset** command at the **RedBoot>** prompt for the DeviceMaster UP to begin operation.

Note: The [LEDs](#) on the DeviceMaster UP will go through the power up sequence. The DeviceMaster UP has completed its reset cycle when the **Status LED** is lit and it stops flashing.

```
RedBoot> dis
Loading disabled
RedBoot> reset
```

Configuring Passwords

This section discusses how to configure a password for the web and telnet server.

Use the following procedure to establish the DeviceMaster UP password for the Web and telnet server. Establishing a password prevents unauthorized changes to the DeviceMaster UP configuration.

1. Establish communications with the DeviceMaster UP using the serial (Page 42) or telnet method (Page 43).
2. Type **password [your_password]** and press **Enter**.

Note: If you forget your password, you can reprogram the password using the serial method which bypasses the password.

```
Password:
*****
**
** Control DeviceMaster Bootloader Version 3.23
** RedBoot(tm) environment - built 14:59:20, Oct 13 2011
** Platform: Control DeviceMaster (ARM 7TDMI)
** Portions Copyright (C) 2000. Red Hat, Inc.
** Portions Copyright (C) 2001-2008 Control Corp.
*****

FLASH: 64 blocks of 65536 bytes each
FLASH: 4194304 bytes (0x05000000 - 0x05400000)
RAM: 8126464 bytes (0x00000000 - 0x007c0000)
RedBoot> dis
Loading disabled
RedBoot> password dev1357
Password 'dev1357'
RedBoot>
```

Note: The Bootloader version on your DeviceMaster UP may be different than the version displayed in this graphic.

See the **auth** command in the [RedBoot Command Overview](#) on Page 47, if you want to set up Web browser authentication.

RedBoot Command Overview

The following table is an overview of RedBoot commands available. After accessing RedBoot, you can review the list of commands online by entering **help** and pressing the **Enter** key.

For more detailed information, see the *eCos Reference Manual* that is located on the *Control Software and Documentation* CD or you can download it from: .

RedBoot Commands	
auth {noaccess, none, basic, md5, invalid}	Sets or displays web authentication. The default is set to none , which means that there is no authentication required to access the web server. To deny access to the web server, click noaccess or invalid . If access is attempted, a message appears to notify the user that access is denied. To configure the web server to request an un-encrypted password, click basic . To configure the web server to request an encrypted password, click md5 . (Some browsers do not support the md5 command.)
boardrev †	Displays the board revision.
cache [ON OFF]	Manages machine caches.
channel [-1 <channel number>]	Displays or switches the console channel.
chassis	Displays chassis information.
cksum -b <location> -l <length>	Computes a 32-bit checksum [POSIX algorithm] for a range of memory.
disable	Disables automatic load of the default application.
dump -b <location> [-l <length>] [-s] [-1 2 4]	Displays (hex dump) of a range of memory.
fis {cmds}	Manages flash images. See Chapter 2 of the eCos Reference Manual for {cmds} information.
flash	Shows flash information.
go [-w <timeout>] [-c] [-n] [entry]	Executes code at a location.
help <topic>	Displays available RedBoot commands.
history	Displays command history.
ip [addr mask gateway]	Displays or sets the IP address configuration.
load [-r] [-v] [-h <host>] [-p <TCP port>] [-m <varies>] [-c <channel_number>] [-b <base_address>] <file_name>	Loads a file from TFTP server or XModem.
loop 232 422 int port-number	Runs loopback test on port. The DeviceMaster Serial Hub does not support this command.
mac †	Displays ethernet MAC address.
mcmp -s <location> -d <location> -l <length> [-1 -2 -4]	Compares two blocks of memory.

RedBoot Commands (Continued)	
mcopy -s <location> -d <location> -l <length> [-1 -2 -4]	Copies memory from one address to another.
mfill -b <location> -l <length> -p <pattern> [-1 -2 -4]	Fills a block of memory with a pattern.
model†	Shows model number.
password {password}	Sets or deletes the password.
ping [-v] [-n <count>] [-l <length>] [-t <timeout>] [-r <rate>] [-i <IP_addr>] -h <IP_addr>	Network connectivity test.
reset	Resets the DeviceMaster UP.
secureconf [disable enable]	Sets or displays secure config enable.
securedata [disable enable]	Sets or displays secure data enable.
sernum [prefix] [serial_number] sernum [serial_number]†	Displays device serial number (if available).
?	Displays short help.
snmp [disable enable]	Sets or displays SNMP enable.
summary	Displays a summary that includes the bootloader version, network address information, MAC address, and security settings.
telnet [disable enable]	Sets or displays telnet server enable. Disables telnet.
tetimeout [seconds]	Shows or sets telnet time-out.
terse	Terse command response mode.
timeout {seconds}	Displays or sets Bootloader time-out value.
version	Displays RedBoot version information.
x -b <location> [-l <length>] [-s] [-1 2 4]	Displays (hex dump) a range of memory.
<i>† Read-only items that you cannot change in Redboot.</i>	

Hardware Specifications

Locating DeviceMaster UP Specifications

Specifications can be found on the Control web site (www.comtrol.com).

External Power Supply Specifications

This subsection discusses information that you may need if you wish to use your own external power supplies.

This table provides specifications for the power supply shipped with the DeviceMaster UP.

Control Power Supply: 5-30VDC	
Input line frequency	43-63 Hz
Input line voltage	90-260 VAC
Output voltage	5-30VDC
Output current	275 mA @ 24VDC

This table provides the specifications, if you intend on using your own power.

External Power Supply: 5-30VDC	
Output voltage†	5-30VDC
Current†	200 mA (Min) @ 24VDC
Power	4.5 W
† Any power supply that meets current consumption, voltage, power, and connector pinouts requirements can be used.	

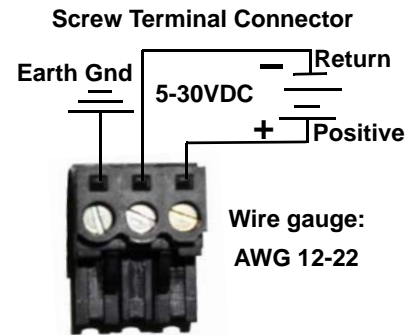

Notices

Radio Frequency Interference (RFI) (FCC 15.105)

This equipment has been tested and found to comply with the limits for Class A digital devices pursuant to Part 15 of the FCC Rules.

This equipment generates, uses, and can radiate radio frequency energy, and if not installed and used in accordance with the instruction manual, may cause harmful interference to radio communications. However, there is no guarantee that interference will not occur in a particular installation. If this equipment does cause harmful interference to radio or television reception, which can be determined by turning the equipment off and on, the user is encouraged to try and correct the interference by one or more of the following measures:

- Reorient or relocate the receiving antenna.
- Increase the separation between the equipment and the receiver.
- Connect the equipment into an outlet on a circuit different from that to which the receiver is connected.
- Consult the dealer or an experienced radio/TV technician for help.

Labeling Requirements (FCC 15.19)

This equipment complies with part 15 of FCC rules. Operation is subject to the following two conditions:

- This device may not cause harmful interference.
- This device must accept any interference received, including interference that may cause undesired operation.

Modifications (FCC 15.21)

Changes or modifications to this equipment not expressly approved by Comtrol Corporation may void the user's authority to operate this equipment.

Serial Cables (FCC 15.27)

This equipment is certified for Class A operation when used with unshielded cables on models with the RJ45 connectors and with shielded cables on all models with DB9 connectors.

Underwriters Laboratory

This equipment is Underwriters Laboratory "UL" listed.

Important Safety Information



To avoid contact with electrical current:

- Never install electrical wiring during an electrical storm.
- Never install the power plug in wet locations.
- Use a screwdriver and other tools with insulated handles.

Troubleshooting and Technical Support

This section contains troubleshooting information for your DeviceMaster UP. You may want to review the following subsections before calling Technical Support because they will request that you perform many of the procedures or verifications before they will be able to help you diagnose a problem.

- [Troubleshooting Checklist](#) on Page 51
- [General Troubleshooting](#) on Page 52
- [DeviceMaster UP LEDs](#) on Page 53

If you cannot diagnose the problem, you can contact [Technical Support](#) on Page 54.

Troubleshooting Checklist

The following checklist may help you diagnose your problem:

- Verify that you are using the correct types of cables on the correct connectors and that all cables are connected securely.

Note: Most customer problems reported to Control Technical Support are eventually traced to cabling or network problems.

Model	Connected to	Ethernet Cable	Connector Name
16-Port - 2E (Dual Ethernet Ports)	Ethernet hub or NIC	Standard	10/100

- Verify that the network IP address, subnet mask, and gateway is correct and appropriate for the network. Make sure that the IP address programmed into the DeviceMaster UP matches the unique reserved IP configured address assigned by the system administrator.
 - If IP addressing is being used, the system should be able to ping the DeviceMaster UP.
 - If using DHCP, the host system needs to provide the subnet mask and gateway.
- Verify that the Ethernet hub and any other network devices between the system and the DeviceMaster UP are powered up and operating.
- Reboot the system, then reset the power on the DeviceMaster UP and watch the **Status** (Page 53) light activity.

Status LED	Description
5 quick flashes	The default application is starting up.
10 sec. on. 1 sec. off, 10 sec. on. 1 sec. off...	The default application is running.

- If you have a spare DeviceMaster UP, try replacing the device.

General Troubleshooting

This table illustrates some general troubleshooting tips.

Note: Make sure that you have reviewed the [Troubleshooting Checklist](#) on Page 51.

General Condition	Explanation/Action
Status LED flashing	Indicates that boot program has not downloaded to the unit. 1. Reboot the system. 2. Make sure that you have downloaded the most current firmware for your protocol . <i>Note: If the PWR or Status LED is still flashing, contact Technical Support.</i>
Status LED not lit	Indicates that power has not been applied or there is a hardware failure. Contact Technical Support.
Cannot ping the device through Ethernet hub	Isolate the DeviceMaster UP from the network. Connect the device directly to the NIC in the host system.
Cannot ping or connect to the DeviceMaster UP	The default DeviceMaster UP IP address is often not accessible due to the subnet masking from another network unless 192.168 is used in the network. In most cases, it will be necessary to program in an address that conforms to your network.
DeviceMaster UP continuously reboots when connected to some Ethernet switches or routers	Invalid IP information may also cause the switch or router to check for a gateway address. Lack of a gateway address is a common cause.

DeviceMaster UP LEDs

The DeviceMaster UP has network and port LEDs to indicate status. This subsection discusses:

- [TX/RX LEDs](#)
- [Network and Device LEDs](#) on Page 53

TX/RX LEDs

This subsection discusses RX and TX LEDs on the DeviceMaster LT.

The RX (yellow) and TX (green) LEDs function accordingly when the cable is attached properly to a serial device.

Note: *The RX/TX LEDs cycle during the reboot cycle.*

The LEDs do not function as described until the port has been opened by an application.

You can use Test Terminal to open a port or ports if you want to test a port or ports.

The RX (green) and TX (yellow) LEDs functions are displayed in the following table when the cable is attached properly to a serial device.

LED	Mode	Description	LED Status
RX (Green)	RS-232	No valid RS-232 device is connected	Always off
		Valid RS-232 device is connected but no data transmission is occurring	On
		Data being received	LED blinks
	RS-422/485	No data being received	Always off
		Data being received	LED blinks
		No mode	No mode selected
TX (Yellow)	RS-232/422/485	No data being transmitted	Always off
		Data being transmitted	LED blinks

Network and Device LEDs

The LEDs indicate that the default DeviceMaster UP application is running. If you have loaded PortVision DX, you can check the DeviceMaster UP status online.

- If the **Status** LED on the DeviceMaster LT is lit, it indicates the DeviceMaster LT has power and it has completed the boot cycle.

The Status LED flashes while booting and it takes approximately 15 seconds for the Bootloader to complete the cycle. When the Bootloader completes the cycle, the LED has a solid, steady light that blinks approximately every 10 seconds.

- The green Ethernet LED indicates that a link has been established and the yellow Ethernet LED indicates activity.

Technical Support

It contains troubleshooting procedures that you should perform before contacting Technical Support since they will request that you perform, some or all of the procedures before they will be able to help you diagnose your problem. If you need technical support .

Control Contact Information	
Downloads	ftp://ftp.control.com/html/up_main.htm
Web site	http://www.comtrol.com
Phone	(763) 957-6000