

# EtherNet/IP



## Hardware Installation and Configuration Guide



### ***Trademark Notices***

Control, DeviceMaster, and PortVision are registered trademarks of Control Corporation.

Ethernet is a registered trademark of Digital Equipment Corporation, Intel, and Xerox Corporation.

Microsoft and Windows are registered trademarks of Microsoft Corporation in the United States and/or other countries.

Modbus is a registered trademark of Schneider Electric.

PLC is a registered trademark of Allen-Bradley Company, Inc.

RedBoot is a trademark of Red Hat, Inc.

SIMATIC is a registered trademark of Siemens, AG.

Portions of SocketServer are copyrighted by GoAhead Software, Inc. Copyright © 2001. GoAhead Software, Inc. All Rights Reserved.

Other product names mentioned herein may be trademarks and/or registered trademarks of their respective owners.

Third Edition, November 28, 2018

Copyright © 2005 - 2018. Control Corporation.

All Rights Reserved.

Control Corporation makes no representations or warranties with regard to the contents of this document or to the suitability of the Control product for any particular purpose. Specifications subject to change without notice. Some software or features may not be available at the time of publication. Contact your reseller for current product information.

**Document Number: 2000633 Rev. C**

**Previous Part Number/Revision: 2000451 Rev K**

# Table of Contents

<b>Getting Started .....</b>	<b>7</b>
<b>Quick Start .....</b>	<b>7</b>
<b>Locating Software and Documentation .....</b>	<b>8</b>
<b>Hardware Installation.....</b>	<b>9</b>
<b>Installation Overview .....</b>	<b>9</b>
<b>Product Name Change Notification .....</b>	<b>10</b>
<b>1-Port - Panel Mount (DB9) Installation .....</b>	<b>10</b>
<b>EIP-2201: 1-Port DIN Rail (Terminal Block) Installation.....</b>	<b>12</b>
<b>EIP-2101: 1-Port DIN Rail (DB9) Installation.....</b>	<b>13</b>
<b>EIP-2202 and EIP-2402: 2-Port DIN Rail (Terminal Block) Installation .....</b>	<b>14</b>
<b>EIP-2102 and EIP-2302: 2-Port DIN Rail (DB9) Installation .....</b>	<b>16</b>
<b>EIP-2304: 4-Port DIN Rail (DB9) Installation.....</b>	<b>18</b>
<b>4-Port Panel Mount Installation .....</b>	<b>19</b>
<b>Adding a Unit to an Existing Installation.....</b>	<b>20</b>
<b>Replacing Hardware .....</b>	<b>20</b>
<b>Preparing the DeviceMaster for Configuration.....</b>	<b>21</b>
<b>PortVision DX Overview .....</b>	<b>21</b>
<b>PortVision DX Requirements.....</b>	<b>22</b>
<b>Installing PortVision DX.....</b>	<b>22</b>
<b>Configuring the Network Settings .....</b>	<b>25</b>
<b>Checking the Protocol Firmware Version.....</b>	<b>28</b>
<b>Uploading Protocol-Specific Firmware on the DeviceMaster .....</b>	<b>29</b>
<b>Customizing PortVision DX .....</b>	<b>31</b>
<b>Accessing DeviceMaster Documentation from PortVision DX.....</b>	<b>32</b>
How to Download Documentation .....	32
How to Open Previously Downloaded Documents .....	33
<b>Connecting Serial Devices .....</b>	<b>35</b>
<b>DB9 Connectors .....</b>	<b>36</b>
DB9 Null-Modem Cables (RS-232) .....	37
DB9 Null-Modem Cables (RS-422) .....	37
DB9 Straight-Through Cables (RS-232/485).....	37
DB9 Loopback Plugs.....	38
Connecting DB9 Serial Devices .....	38
<b>RJ45 Connectors .....</b>	<b>39</b>
RJ45 Null-Modem Cables (RS-232) .....	39
RJ45 Null-Modem Cables (RS-422) .....	40
RJ45 Straight-Through Cables (RS-232/485).....	40
RJ45 Loopback Plugs.....	40
RJ45 RS-485 Test Cable.....	40
Connecting RJ45 Devices .....	41

- Four Screw Terminals (EIP-2202).....42**
  - Serial Terminal (4) Connectors ..... 42
  - Serial Terminal (4) Null-Modem Cables (RS-232) ..... 43
  - Serial Terminal (4) Null-Modem Cables (RS-422) ..... 43
  - Serial Terminal (4) Straight-Through Cables (RS-232/485) ..... 44
  - Serial Terminal (4) Loopback Signals ..... 44
  - Connecting Serial Devices ..... 44
- Eight Screw Terminals (EIP-2402).....45**
  - Screw Terminal (8) Connectors ..... 45
  - Screw Terminal (8) Null-Modem Cables (RS-232) ..... 46
  - Screw Terminal (8) Null-Modem Cables (RS-422) ..... 46
  - Screw Terminal (8) Straight-Through Cables (RS-232/485) ..... 47
  - Screw Terminal (8) Loopback Signals ..... 47
  - Connecting Serial Devices ..... 47
- Nine Screw Terminals (EIP-2201).....48**
  - Screw Terminal Connectors (9)..... 48
  - Screw Terminal (9) Null-Modem RS-232 Cables ..... 48
  - Screw Terminal (9) Null-Modem RS-422 Cables ..... 49
  - Screw Terminal (9) RS-232/485 Straight-Through Cables ..... 49
  - Screw Terminal (9) Loopback Signals ..... 50
  - Connecting Serial Devices ..... 50
- Managing the DeviceMaster .....51**
  - Rebooting the DeviceMaster.....51**
  - Uploading Firmware to Multiple DeviceMasters.....52**
  - Configuring Multiple DeviceMasters Network Addresses .....53**
  - Adding a New Device in PortVision DX .....53**
    - Remote Using the IP Address ..... 53
    - Local Using the IP Address or MAC Address ..... 54
  - Changing the Bootloader Timeout .....55**
  - Using Configuration Files .....56**
    - Saving Configuration Files..... 56
    - Loading Configuration Files ..... 57
  - Managing Bootloader .....59**
    - Checking the Bootloader Version..... 59
    - Uploading Bootloader ..... 59
  - Restoring Factory Defaults (Specific Models - Reset Button) .....61**
  - Restoring Defaults.....61**
  - Accessing RedBoot Commands in Telnet/SSH Sessions (PortVision DX) .....62**
- RedBoot Procedures.....65**
  - Accessing RedBoot Overview .....65**
  - Establishing a Serial Connection .....66**
  - Establishing a Telnet Connection.....67**
  - Determining the Network Settings .....68**
  - Configuring the Network Settings .....68**
  - Changing the Bootloader Timeout .....69**
  - Determining the Bootloader Version.....69**
  - Resetting the DeviceMaster .....70**
  - Configuring Passwords .....70**
  - RedBoot Command Overview.....71**

---

<b>External Power Supply Specifications .....</b>	<b>73</b>
<b>1-Port Panel Mount 5-30VDC Power Supply .....</b>	<b>73</b>
<b>EIP-2101 and EIP-2201: 1-Port DIN Rail Power Supply .....</b>	<b>74</b>
<b>EIP-2202 and EIP-2402: 2-Port (Serial Terminals) Power Supply.....</b>	<b>75</b>
<b>EIP-2102 and EIP-2302: 2-Port DB9 Power Supply (Bottom) .....</b>	<b>76</b>
<b>EIP-2102 and EIP-2302: 2-Port DB9 Power Supply (Top).....</b>	<b>77</b>
<b>EIP-2304: 4-Port DIN Rail Models Power Supply.....</b>	<b>78</b>
<b>4-Port Panel Mount Power Supply .....</b>	<b>78</b>
<b>Troubleshooting and Technical Support.....</b>	<b>79</b>
<b>Troubleshooting Checklist .....</b>	<b>79</b>
<b>General Troubleshooting.....</b>	<b>81</b>
<b>Daisy-Chaining DeviceMaster 4-Port Units .....</b>	<b>82</b>
<b>DeviceMaster LEDs.....</b>	<b>83</b>
TX/RX LEDs.....	83
Network and Device LEDs.....	83
<b>Technical Support .....</b>	<b>84</b>



# Getting Started

This guide discusses initial DeviceMaster Industrial Gateway installation and hardware configuration for the DeviceMaster EIP and DeviceMaster UP platforms.

The DeviceMaster Industrial Gateway is a network attached, solid-state device server, which hosts an Industrial Ethernet engine and translates device communications to a programmable logic controller (PLC) and any serial device.

This guide does not discuss configuring the port characteristics or protocol-specific programming information. See [Locating Software and Documentation](#) on Page 8 to locate the firmware and the appropriate documentation for your environment.

**Note:** *The DeviceMaster EIP and DeviceMaster UP are often simply referred to as the DeviceMaster in this User Guide.*

When a DeviceMaster is loaded with the appropriate firmware for your DeviceMaster Industrial Gateway, it enables connectivity between any PLC and any serial device.

**Note:** *If you have a DeviceMaster with 16-ports, use the [DeviceMaster UP 16-Port Hardware User Guide](#) because the RJ45 connectors have different pin outs.*

## Quick Start



---



Installation and configuration follows these steps.

1. Connect the hardware (Page 9).
2. Install PortVision DX (Page 22).
3. Configure the DeviceMaster network settings (Page 25).
4. If necessary, update the firmware on the DeviceMaster (Page 29).
5. Use [Locating Software and Documentation](#) on Page 8 to locate the appropriate installation document so that you can perform the following procedures:
  - Configure port characteristics using the *Server Configuration* web page.
  - Program the PLCs.
6. Connect the serial device or devices (Page 35).

## Locating Software and Documentation

You can access the appropriate firmware assembly, PortVision DX, and the DeviceMaster documentation from the download site using the links in the following table.

DeviceMaster EIP   DeviceMaster UP Software and Firmware		Link
Bootloader	<i>Bootloader</i> , the operating system that runs on the DeviceMaster hardware during the power on phase, which then starts the default application, EtherNet/IP.	
PortVision DX	<p><i>PortVision DX</i> is the application for Windows that you use to configure network settings and update the firmware.</p> <p>Use PortVision DX to manage Control Ethernet-attached devices to:</p> <ul style="list-style-type: none"> <li>• Scan the network for attached devices</li> <li>• View networked devices in real-time</li> <li>• Access product-specific network settings configurations</li> <li>• Assign IP addresses and network settings to one or multiple devices</li> <li>• Upload the latest firmware or Bootloader</li> <li>• Save and load configuration files</li> <li>• Access DeviceMaster configuration web pages</li> <li>• Access Telnet/SSH sessions</li> <li>• Remotely reboot devices</li> <li>• Download technical documentation</li> <li>• Enable event logging to assist in monitoring and troubleshooting</li> <li>• Create shortcuts to quickly access your favorite applications</li> <li>• Organize devices into folders and create multiple views</li> <li>• Enter notes about a folder or device</li> </ul>	

EtherNet/IP Firmware and Documentation		Link
Firmware	<b>EtherNet/IP (.msi)</b> file contains the firmware and supporting files. The firmware provides embedded configuration web pages. You may need to update the DeviceMaster with the latest version.	
Documentation	<ul style="list-style-type: none"> <li>• <i>EtherNet/IP Interface Configuration Quick Start</i> contains configuration procedures for the DeviceMaster embedded web pages.</li> <li>• <i>EtherNet/IP User Guide</i> contains detailed protocol-specific information about the DeviceMaster.</li> <li>• <i>DeviceMaster UP Filtering and Data Extraction Reference Guide</i> describes the data extraction and filtering processes provided by the DeviceMaster with EtherNet/IP.</li> </ul>	



# Hardware Installation

## Installation Overview

---

Use the links below to locate installation procedures for the following models:

<b>Ports</b>	<b>DeviceMaster EIP or DeviceMaster UP Model</b>	<b>Installation Procedure</b>
1	Control device DB9 serial port Panel mount	<a href="#">1-Port - Panel Mount (DB9) Installation</a> on Page 10
1	DeviceMaster EIP-2201 Screw terminal serial port DIN rail	<a href="#">EIP-2201: 1-Port DIN Rail (Terminal Block) Installation</a> on Page 12
1	DeviceMaster EIP-2101 DB9 serial port DIN rail	<a href="#">EIP-2101: 1-Port DIN Rail (DB9) Installation</a> on Page 13
2	DeviceMaster EIP-2202 DeviceMaster EIP-2402 Screw terminal serial ports DIN rail	<a href="#">EIP-2202 and EIP-2402: 2-Port DIN Rail (Terminal Block) Installation</a> on Page 14
2	DeviceMaster EIP-2102 DeviceMaster EIP-2302 DB9 serial ports DIN rail	<a href="#">EIP-2102 and EIP-2302: 2-Port DIN Rail (DB9) Installation</a> on Page 16
4	DeviceMaster EIP-2304 DB9 serial ports DIN rail	<a href="#">EIP-2304: 4-Port DIN Rail (DB9) Installation</a> on Page 18
4	Control device DB9 serial ports Panel mount	<a href="#">4-Port Panel Mount Installation</a> on Page 19

## Product Name Change Notification

Control has implemented a product name change for our DeviceMaster 2-port DIN rail models to align with our new 1-port and 4-port DIN rail model names.

Old Name/Description	New Model Name	Part Number
DeviceMaster EIP or DeviceMaster UP 2-Port 1E EtherNet/IP	DeviceMaster EIP-2202	99531-9
DeviceMaster EIP or DeviceMaster UP 2-Port DB9 1E EtherNet/IP	DeviceMaster EIP-2102	99551-7
DeviceMaster EIP or DeviceMaster UP 2-Port 2E EtherNet/IP	DeviceMaster EIP-2402	99541-8
DeviceMaster EIP or DeviceMaster UP 2-Port DB9 2E EtherNet/IP	DeviceMaster EIP-2302	99561-6

## 1-Port - Panel Mount (DB9) Installation

Use the following procedure to install the DeviceMaster 1-Port (panel mount).

1. Place the DeviceMaster 1-Port on a stable surface and skip to [Step 2](#) or optionally mount the DeviceMaster using the mounting flanges or DIN rail adapters.
  - a. Pick up the DeviceMaster so that the front of the device is facing you.
  - b. Pick up a DIN rail clip. (The three tines should be on top and the M4 label should face you.)
  - c. Slide the DIN rail clip behind the DeviceMaster and line it up with one of the screw holes on the DeviceMaster.
  - d. Insert the M4 screw into the hole and tighten with a Phillips screwdriver.
  - e. Repeat [Steps b](#) through d with the second DIN rail clip. Make sure the screws on both DIN rail clips line up.

**Note:** If you need to remove the DeviceMaster from the DIN rail, exert pressure on the backside of the tabs at the bottom of both DIN rail clips.

- f. Attach the DeviceMaster to the DIN rail.

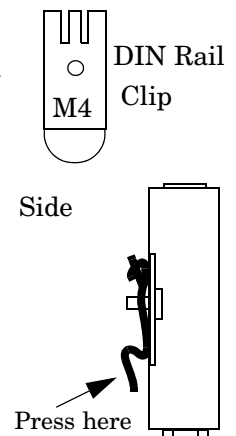
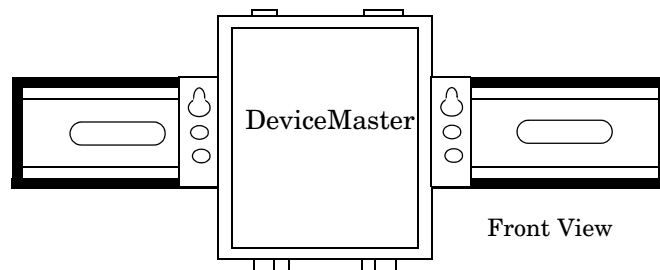

**Note:** Do not connect multiple units until you have changed the default IP address, see [Preparing the DeviceMaster for Configuration](#) on Page 21

2. Connect the DeviceMaster port labeled **10/100 ETHERNET** to the same Ethernet network segment as the PLC using a standard network cable.
3. Apply power to the DeviceMaster using the following procedure.

**Note:** See [1-Port Panel Mount 5-30VDC Power Supply](#) on Page 73, if you want to provide your own power supply.

**Observe proper ESD techniques when connecting and disconnecting the DeviceMaster.**

- Insert the earth ground wire into the earth ground screw terminal.
  - Insert the DC positive wire into the positive screw terminal and the DC return wire into the return screw terminal.
- Refer to [1-Port Panel Mount 5-30VDC Power Supply](#) on Page 73 for detailed power requirements.
- Use a small flat head screw to lock the wires into place.
  - Verify that each wire has been tightened securely.

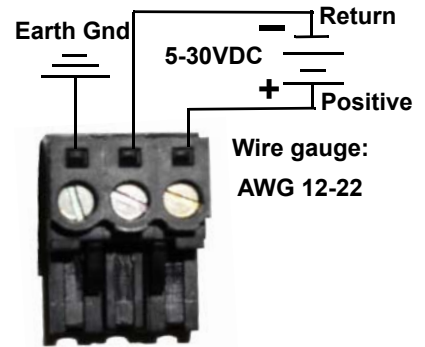

- Plug the screw terminal power connector into the DeviceMaster.
- Note:** Align the plug properly. The scalloped side of the screw terminal power connector should be aligned with the scalloped side of the power jack on the unit.
- Connect the power supply to a power source.
  - Go to [Step 4](#) to verify that the DeviceMaster is functioning properly.



4. Verify that the **Status LED** has completed the boot cycle and network connection for the DeviceMaster is functioning properly using the table below.

1-Port Panel Mount LED Descriptions	
<b>Status</b>	The amber <b>Status LED</b> on the device is lit, indicating you have power and it has completed the boot cycle. <b>Note:</b> The <b>Status LED</b> flashes while booting and it takes approximately 15 seconds for the Bootloader to complete the cycle. When the Bootloader completes the cycle, the LED has a solid, steady light that blinks approximately every 10 seconds.
<b>Link/Act</b>	If the red <b>Link/Act LED</b> is lit, it indicates a working Ethernet connection.
<b>Duplex</b>	If the red <b>Duplex LED</b> is lit, it indicates full-duplex activity.
<b>100</b>	If the red <b>100 LED</b> is lit, it indicates a working 100 MB Ethernet connection (100 MB network, only). If the LED is not lit, it indicates a 10 MB Ethernet connection.
<b>Note:</b> For additional LED information, go to the <a href="#">Status LED table</a> on Page 80.	



**Do not connect RS-422/485 devices until the IP address is configured and an appropriate port interface type has been configured. The default port setting is RS-232.**

5. Go to [Preparing the DeviceMaster for Configuration](#) on Page 21 to install PortVision DX, configure the network settings, and if necessary, upload the appropriate protocol firmware on the DeviceMaster.

## EIP-2201: 1-Port DIN Rail (Terminal Block) Installation

Use the following procedure to install EIP-2201. See [EIP-2101: 1-Port DIN Rail \(DB9\) Installation](#) on Page 13 if the DeviceMaster has DB9 serial connectors.

1. Attach the EIP-2201 1-Port to the DIN rail adapter.
2. Connect the power supply and apply power to the EIP-2201 using the power supply specifications on the product label and the following information.



**Observe proper ESD techniques when connecting and disconnecting the DeviceMaster.**

- a. If the DIN rail is not connected to earth ground, insert the earth ground wire into the chassis ground screw terminal.

**Note:** The chassis ground connection is made only if the DIN rail is NOT connected to earth ground.

- b. Insert the DC positive wire into the + screw terminal and the DC return wire into the - screw terminal.

Refer to [EIP-2101 and EIP-2201: 1-Port DIN Rail Power Supply](#) on Page 74 for detailed power requirements.

- c. Use a small flat head screw driver to lock the wires into place.
- d. Verify that each wire has been tightened securely.
- e. Connect a UL Listed power supply and UL Listed power cord to a power source to apply power.

**Note:** Do not connect multiple units until you have changed the default IP address, see [Preparing the DeviceMaster for Configuration](#) on Page 21

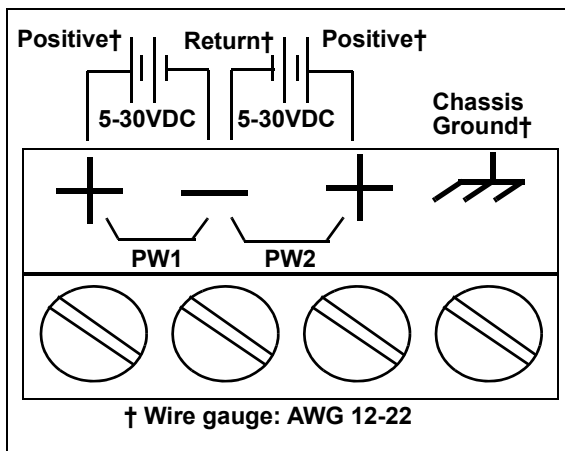

3. Connect the 10/100 port to the same Ethernet network segment as the host PC using a standard network cable.
4. Verify that the Status LED has completed the boot cycle and network connection for the EIP-2201 is functioning using the following table.

EIP-2201 LED Descriptions	
STATUS	The STATUS LED on the device is lit, indicating you have power and it has completed the boot cycle. <b>Note:</b> The Status LED flashes while booting and it takes approximately 15 seconds for the Bootloader to complete the cycle. When the Bootloader completes the cycle, the LED has a solid, steady light that blinks approximately every 10 seconds.
LINK	If the LINK (green) LED is lit, it indicates a working Ethernet connection.
ACT	If the ACT (yellow) LED flashes, it indicates network activity.
<b>Note:</b> For additional LED information, go to the <a href="#">Status LED table</a> on Page 80.	



**Do not connect RS-422/485 devices until the IP address is configured and an appropriate port interface type has been configured. The default port setting is RS-232.**

5. Go to [Preparing the DeviceMaster for Configuration](#) on Page 21 for default network settings and how to configure the DeviceMaster for use.

## EIP-2101: 1-Port DIN Rail (DB9) Installation

Use the following procedure to install a EIP-2101.

1. Attach the EIP-2101 to the DIN rail adapter.
2. Connect the power supply and apply power to the EIP-2101 using the power supply specifications on the product label and the following information.



**Observe proper ESD techniques when connecting and disconnecting the DeviceMaster.**

- a. If the DIN rail is not connected to earth ground, insert the earth ground wire into the chassis ground screw terminal.

**Note:** *The chassis ground connection is made only if the DIN rail is NOT connected to earth ground.*

- b. Insert the DC positive wire into one of the + screw terminals and the DC return wire into the - screw terminal.
  - A second redundant power supply can be connected to the unit by inserting the DC positive wire into the other + screw terminal and the DC return wire into the - screw terminal.
  - The EIP-2101 continues to operate if one of the two connected power supplies should fail.

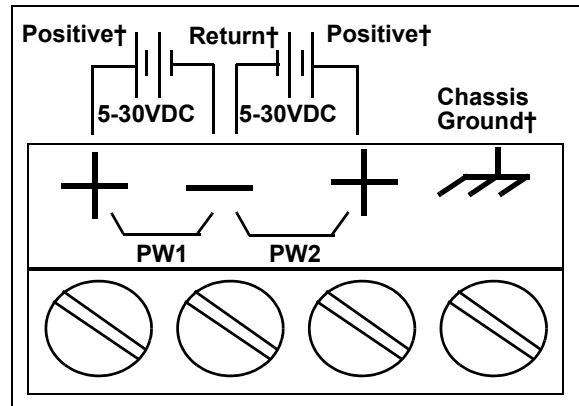

† Wire gauge: AWG 12-22

Refer to [EIP-2101 and EIP-2201: 1-Port DIN Rail Power Supply](#) on Page 74 for detailed power requirements.

- c. Use a small flat head screw driver to lock the wires into place.
- d. Verify that each wire has been tightened securely.
- e. Connect a UL Listed power supply and UL Listed power cord to a power source to apply power.

**Note:** *Do not connect multiple units until you have changed the default IP address, see [Preparing the DeviceMaster for Configuration](#) on Page 21*

3. Connect the 10/100 port to the same Ethernet network segment as the host PC using a standard Ethernet cable.
4. Verify that the Status LED has completed the boot cycle and network connection for the EIP-2101 is functioning properly using the following table.

EIP-2101 LED Descriptions	
STATUS	The STATUS LED is lit, indicating you have power and it has completed the boot cycle. <b>Note:</b> <i>The Status LED flashes while booting and it takes approximately 15 seconds for the Bootloader to complete the cycle. When the Bootloader completes the cycle, the LED has a solid, steady light that blinks approximately every 10 seconds.</i>
LINK	If the LINK (green) LED is lit, it indicates a working Ethernet connection.
ACT	If the ACT (yellow) LED flashes, it indicates network activity.
<b>Note:</b> <i>For additional LED information, go to the <a href="#">Status LED table</a> on Page 80.</i>	



**Do not connect RS-422/485 devices until the IP address is configured and an appropriate port interface type has been configured. The default port setting is RS-232.**

- Go to [Preparing the DeviceMaster for Configuration](#) on Page 21 for default network settings and how to configure the DeviceMaster for use.

## EIP-2202 and EIP-2402: 2-Port DIN Rail (Terminal Block) Installation

Use the following procedure to install the EIP-2202 and EIP-2402. See [EIP-2102 and EIP-2302: 2-Port DIN Rail \(DB9\) Installation](#) on Page 16 if the DeviceMaster has DB9 serial connectors.

- Attach the DeviceMaster to the DIN rail adapter.
- Connect the power supply and apply power to the DeviceMaster using the power supply specifications on the product label and the following information.



**Observe proper ESD techniques when connecting and disconnecting the DeviceMaster.**

- If the DIN rail is not connected to earth ground, insert the earth ground wire into the chassis ground screw terminal.

**Note:** *The chassis ground connection is made only if the DIN rail is NOT connected to earth ground.*

- Insert the DC positive wire into the + screw terminal and the DC return wire into the - screw terminal.

Refer to [EIP-2202 and EIP-2402: 2-Port \(Serial Terminals\) Power Supply](#) on Page 75 for power requirements.

- Use a small flat head screw driver to lock the wires into place.
- Verify that each wire has been tightened securely.
- Connect a UL Listed power supply and UL Listed power cord to a power source to apply power.

**Note:** *Do not connect multiple units until you have changed the default IP address, see [Preparing the DeviceMaster for Configuration](#) on Page 21*

- Use the appropriate method for network attachment of the DeviceMaster.

- EIP-2202:** Connect the **10/100 port** to the same Ethernet network segment as the host PC using a standard network cable.
- EIP-2402:** Connect the DeviceMaster using either Ethernet port to the same Ethernet network segment as the host PC using a standard Ethernet cable. You can daisy-chain another DeviceMaster or Ethernet device to the other Ethernet port.

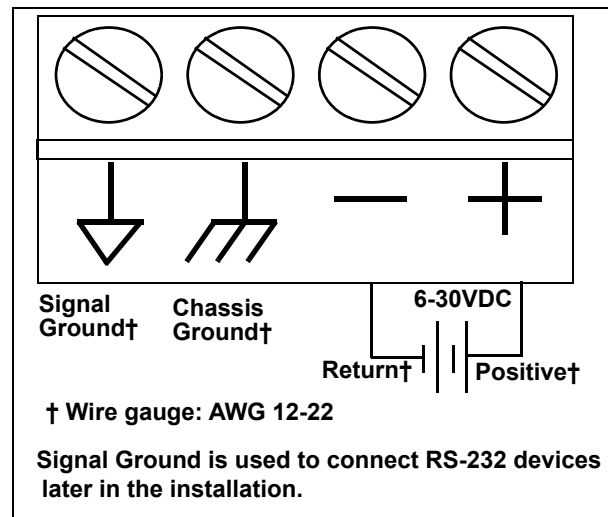

4. Verify that the **Status LED** has completed the boot cycle and network connection for the DeviceMaster is functioning properly using the following table.

<b>EIP-2202 and EIP-2402 (2-Port with Serial Terminal Connectors) LED Descriptions</b>	
<b>STATUS</b>	The <b>STATUS LED</b> is lit, indicating you have power and it has completed the boot cycle. <i><b>Note:</b> The Status LED flashes while booting and it takes approximately 15 seconds for the Bootloader to complete the cycle. When the Bootloader completes the cycle, the LED has a solid, steady light that blinks approximately every 10 seconds.</i>
<b>LINK</b>	If the <b>LINK</b> (green) LED is lit, it indicates a working Ethernet connection.
<b>ACT</b>	If the <b>ACT</b> (yellow) LED flashes, it indicates network activity.
<i><b>Note:</b> For additional LED information, go to the <a href="#">Status LED table</a> on Page 80.</i>	



**Do not connect RS-422/485 devices until the IP address is configured and an appropriate port interface type has been configured. The default port setting is RS-232.**

5. Go to [Preparing the DeviceMaster for Configuration](#) on Page 21 for default network settings and how to configure the DeviceMaster for use.



## EIP-2102 and EIP-2302: 2-Port DIN Rail (DB9) Installation

Use the following procedure to install EIP-2102 and EIP-2302.

1. Attach the DeviceMaster to the DIN rail adapter.
2. Connect the power supply and apply power to the DeviceMaster using the power supply specifications on the product label and the following information.



**Observe proper ESD techniques when connecting and disconnecting the DeviceMaster.**

- a. If the DIN rail is not connected to earth ground, insert the earth ground wire into the chassis ground screw terminal.

**Note:** The chassis ground connection is made only if the DIN rail is NOT connected to earth ground.

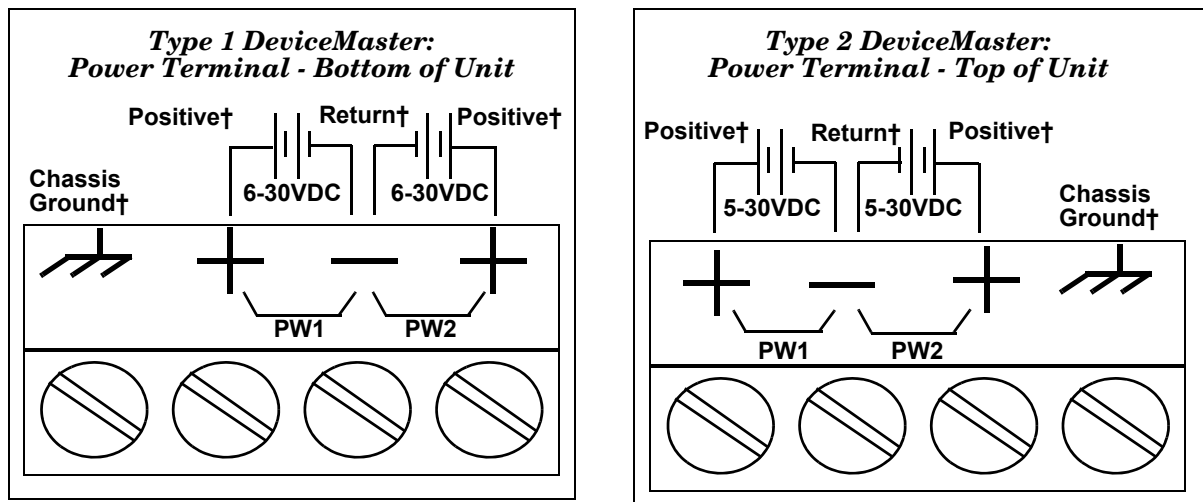

† Wire gauge: AWG 12-22

- b. Insert the DC positive wire into one of the + screw terminals and the DC return wire into the - screw terminal.

**Type 1:** 6-30VDC - serial number less than xxxx-030000.

**Type 2:** 5-30VDC - serial number greater than xxxx-030000.

A second redundant power supply can be connected to the unit by inserting the DC positive wire into the other + screw terminal and the DC return wire into the - screw terminal. The DeviceMaster continues to operate if one of the two connected power supplies should fail.

Refer to the appropriate subsection for detailed power requirements.

- [EIP-2102 and EIP-2302: 2-Port DB9 Power Supply \(Bottom\)](#) on Page 76
- [EIP-2102 and EIP-2302: 2-Port DB9 Power Supply \(Top\)](#) on Page 77

- c. Use a small flat head screw driver to lock the wires into place.
- d. Verify that each wire has been tightened securely.
- e. Connect a UL Listed power supply and UL Listed power cord to a power source to apply power.

**Note:** Do not connect multiple units until you have changed the default IP address, see [Preparing the DeviceMaster for Configuration](#) on Page 21.



3. Use the appropriate method for network attachment of your DeviceMaster 2-port:
  - **EIP-2102:** Connect the **10/100 port** to the same Ethernet network segment as the host PC using a standard network cable.
  - **EIP-2302:** Connect either **10/100 port** to the same Ethernet network segment as the host PC using a standard network cable. You can daisy-chain another DeviceMaster or Ethernet device to the other Ethernet port.
4. Verify that the **Status LED** has completed the boot cycle and network connection for the DeviceMaster is functioning using the following table.

<b>EIP-2102 and EIP-2302 (2-Port with DB9 Connectors) LED Descriptions</b>	
<b>STATUS</b>	The <b>STATUS LED</b> on the device is lit, indicating you have power and it has completed the boot cycle. <i><b>Note:</b> The Status LED flashes while booting and it takes approximately 15 seconds for the Bootloader to complete the cycle. When the Bootloader completes the cycle, the LED has a solid, steady light that blinks approximately every 10 seconds.</i>
<b>LINK</b>	If the <b>LINK</b> (green) LED is lit, it indicates a working Ethernet connection.
<b>ACT</b>	If the <b>ACT</b> (yellow) LED flashes, it indicates network activity.
<i><b>Note:</b> For additional LED information, go to the <a href="#">Status LED table</a> on Page 80.</i>	



**Do not connect RS-422/485 devices until the IP address is configured and an appropriate port interface type has been configured. The default port setting is RS-232.**

5. Go to [Preparing the DeviceMaster for Configuration](#) on Page 21 for default network settings and how to configure the DeviceMaster for use.

## EIP-2304: 4-Port DIN Rail (DB9) Installation

Use the following procedure to install EIP-2304.

1. Attach the DeviceMaster to the DIN rail adapter.
2. Connect the power supply and apply power to the DeviceMaster using the power supply specifications on the product label and the following information.



**Observe proper ESD techniques when connecting and disconnecting the DeviceMaster.**

- a. If the DIN rail is not connected to earth ground, insert the earth ground wire into the chassis ground screw terminal.

**Note:** *The chassis ground connection is made only if the DIN rail is NOT connected to earth ground.*

- b. Insert the DC positive wire into one of the + screw terminals and the DC return wire into the - screw terminal.
  - A second redundant power supply can be connected to the unit by inserting the DC positive wire into the other + screw terminal and the DC return wire into the - screw terminal.
  - The DeviceMaster continues to operate if one of the two connected power supplies should fail.

Refer to [EIP-2304: 4-Port DIN Rail Models Power Supply](#) on Page 78 for detailed power requirements.

- c. Use a small flat head screw driver to lock the wires into place.
- d. Verify that each wire has been tightened securely.
- e. Connect a UL Listed power supply and UL Listed power cord to a power source to apply power.

**Note:** *Do not connect multiple units until you have changed the default IP address, see [Preparing the DeviceMaster for Configuration](#) on Page 21*

3. Connect one of the 10/100 ports to the same Ethernet network segment as the host PC using a standard Ethernet cable. You can daisy-chain another DeviceMaster or Ethernet device to the other port using a standard Ethernet cable.
4. Verify that the Status LED has completed the boot cycle and network connection for the DeviceMaster is functioning properly using the following table.

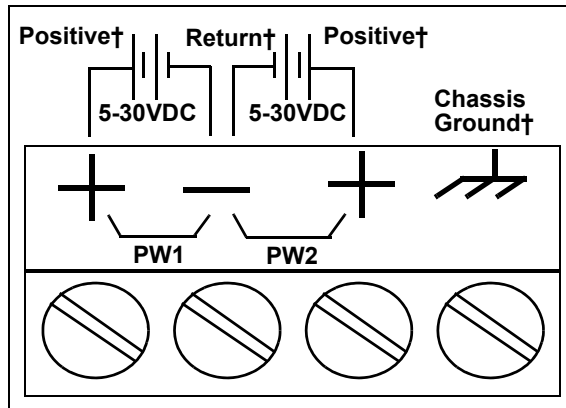

† Wire gauge: AWG 12-22

EIP-2304 LED Descriptions	
STATUS	The STATUS LED is lit, indicating you have power and it has completed the boot cycle. <b>Note:</b> <i>The Status LED flashes while booting and it takes approximately 15 seconds for the Bootloader to complete the cycle. When the Bootloader completes the cycle, the LED has a solid, steady light that blinks approximately every 10 seconds.</i>
LINK	If the LINK (green) LED is lit, it indicates a working Ethernet connection.
ACT	If the ACT (yellow) LED flashes, it indicates network activity.
<b>Note:</b> <i>For additional LED information, go to the <a href="#">Status LED table</a> on Page 80.</i>	



**Do not connect RS-422/485 devices until the IP address is configured and an appropriate port interface type has been configured. The default port setting is RS-232.**

- Go to [Preparing the DeviceMaster for Configuration](#) on Page 21 for default network settings and how to configure the DeviceMaster for use.

## 4-Port Panel Mount Installation

Use the following procedure to install the DeviceMaster 4-port.

- Optionally, attach the mounting brackets using the screws provided in the kit (6-32 1/4" flathead machine) or place the DeviceMaster on a stable surface.



**Failure to use the correct screws can damage the PCB and void the warranty. Do NOT use screws that exceed the length of the screws provided with the mounting bracket kit.**

**Note:** If you ordered the DeviceMaster Rackmount Shelf Kit accessory, use the document that accompanied that kit or [download the document](#) to mount the DeviceMaster on the shelf.

- Connect the DeviceMaster to the same Ethernet network segment as the PLC. If the DeviceMaster serial number is below xxxx-030000 use one of the following methods to connect the cable. Serial numbers above xxxx-030000, the Ethernet port are interchangeable.
  - Ethernet hub or switch (10/100Base-T):** Connect to the port labeled **UP** on the DeviceMaster using a standard Ethernet cable.
  - Server NIC (10/100Base-T):** Connect to the port labeled **DOWN** on the DeviceMaster using a standard Ethernet cable.
  - Daisy-chaining DeviceMaster units:** Connect the port labeled **DOWN** on the first DeviceMaster to the port labeled **UP** on the second DeviceMaster or other device using a standard Ethernet cable. Refer to [Daisy-Chaining DeviceMaster 4-Port Units](#) on Page 82.

**Note:** Do not connect multiple units until you have changed the default IP address, see [Preparing the DeviceMaster for Configuration](#) on Page 21

- Apply power to the DeviceMaster by connecting the AC power adapter to the DeviceMaster, the appropriate power cord for your location to the power adapter, and plugging the power cord into a power source. If you want to provide a power supply, see [4-Port Panel Mount Power Supply](#) on Page 78.
- Verify that the **PWR** LED has completed the boot cycle and the network connection for the DeviceMaster is functioning properly.

4-Port LED Descriptions	
<b>PWR</b>	LED on the front panel of the DeviceMaster is lit, indicating you have power and it has completed the boot cycle. <b>Note:</b> The PWR LED flashes while booting and it takes approximately 15 seconds for the Bootloader to complete the cycle. When the Bootloader completes the cycle, the LED has a solid, steady light that blinks approximately every 10 seconds.
<b>LNK ACT</b>	The red LNK ACT LED is lit, indicating that you have a working Ethernet connection.
<b>COL</b>	If the red COL LED is lit, there is a network collision.
<b>100</b>	If the red 100 LED is lit, it indicates a working 100 MB Ethernet connection (100 MB network, only). If the LED is not lit, it indicates a 10 MB Ethernet connection.
<p style="text-align: center;"><b>10/100 NETWORK</b></p> <p style="text-align: center;">LNK ACT COL 100</p> <p style="text-align: center;">UP DOWN</p>	
<b>Note:</b> For additional LED information, go to the <a href="#">Status LED table</a> on Page 80.	



**Do not connect RS-422/485 devices until the IP address is configured and an appropriate port interface type has been configured. The default port setting is RS-232.**

5. Go to [Preparing the DeviceMaster for Configuration](#) on Page 21 to install PortVision DX, configure the network settings, and if necessary, upload the appropriate protocol firmware on the DeviceMaster.

---

## Adding a Unit to an Existing Installation

---

Use this procedure to add another DeviceMaster to an existing configuration.

1. Install the DeviceMaster to an Ethernet hub or server NIC using the appropriate subsection found in [Installation Overview](#) on Page 9.  
**Note:** *Technical support recommends installing one unit at a time and testing that unit when installing multiple units. In the event troubleshooting must be done, a single unit is easier to resolve than several at once.*
2. Power-up the new DeviceMaster and verify that the **PWR** or **Status** LED lights.
3. Program an IP address into the new DeviceMaster using PortVision DX.
4. If necessary, upload the latest firmware.
5. Configure serial ports to support the serial devices or upload configuration files from PortVision DX.
6. Connect the serial devices.

---

## Replacing Hardware

---

Use this procedure to replace hardware.

1. Remove the old unit and attach a new or spare DeviceMaster.
2. Connect the new DeviceMaster to the network hub or server NIC.
3. Apply power to the new DeviceMaster and verify that it passes the power on self-test.
4. Program the IP address of the new DeviceMaster.
5. If necessary, upload the latest protocol firmware.
6. Configure any ports as necessary to match the previous unit or upload configuration files from PortVision DX.
7. Transfer *all* cabling from the old DeviceMaster to the new DeviceMaster.
8. *It is not necessary* to shut down and restart the host PC.

# Preparing the DeviceMaster for Configuration

The DeviceMaster platform includes PortVision DX, which is the management application that you use to manage all Control Ethernet-attached devices.

This section contains these topics:

- [PortVision DX Overview](#)
- [PortVision DX Requirements](#) on Page 22
- [Installing PortVision DX](#) on Page 22
- [Configuring the Network Settings](#) on Page 25
- [Checking the Protocol Firmware Version](#) on Page 28
- [Uploading Protocol-Specific Firmware on the DeviceMaster](#) on Page 29
- [Customizing PortVision DX](#) on Page 31
- [Accessing DeviceMaster Documentation from PortVision DX](#) on Page 32

**Note:** If PortVision DX is already installed, go directly to [Configuring the Network Settings](#) on Page 25 to change the IP address on the DeviceMaster.

## PortVision DX Overview

---

PortVision DX automatically detects Control Ethernet-attached products physically attached to the local network segment so that you can configure the network address, upload firmware, and manage the following products:

- DeviceMaster family
  - DeviceMaster DM-2000 series
  - DeviceMaster EIP-2000 series
  - DeviceMaster MOD-2000 series
  - DeviceMaster PNIO-2000 series
  - DeviceMaster PRO
  - DeviceMaster RTS
  - DeviceMaster Serial Hub
  - DeviceMaster UP
- DeviceMaster LT
- IO-Link Master
- RocketLinx managed switches

In addition to identifying Control Ethernet-attached products, you can use PortVision DX to display any third-party switch and hardware that may be connected directly to those devices. All non-Control products and unmanaged RocketLinx switches are treated as non-intelligent devices and have limited feature support. For example, you cannot configure or update firmware on a third-party switch.

**Note:** There are two versions of PortVision DX. Older hardware with older firmware versions are typically served better using PortVision DX v3.05 and newer hardware with newer firmware versions require the latest version of PortVision DX. You can refer [DeviceMaster EIP | DeviceMaster UP - EtherNet/IP Versions and PortVision DX](#) document on the download site, which defines the firmware version cut offs.

## PortVision DX Requirements

---

---

Use PortVision DX to identify, configure, update, and manage the DeviceMaster on Windows operating systems.

**Note:** There are two versions of PortVision DX. Older hardware with older firmware versions are typically served better using PortVision DX v3.05 and newer hardware with newer firmware versions require the latest version of PortVision DX. You can refer [DeviceMaster EIP | DeviceMaster UP - EtherNet/IP Versions and PortVision DX](#) document on the download site, which defines the firmware version cut offs.

PortVision DX requires that you connect the Control Ethernet-attached product to the same network segment as the Windows host system if you want to be able to scan and locate it automatically during the configuration process.

Before installing PortVision DX, consider the following:

- Use PortVision DX to upload firmware and apply changes to a DeviceMaster that is on the same local network segment as the system on which PortVision DX is installed. You cannot apply changes through PortVision DX to a DeviceMaster that is not on the same local network segment.
- Use PortVision DX to monitor any DeviceMaster on the network. The DeviceMaster does not have to be on the same local network segment as PortVision DX for monitoring purposes.

## Installing PortVision DX

---

---

During initial configuration, PortVision DX automatically detects and identifies DeviceMaster units, if they are in the same network segment.

You can use the link below to download the latest version of PortVision DX.

1. Download PortVision DX: [http://downloads.comtrol.com/dev\\_mstr/portvision\\_dx](http://downloads.comtrol.com/dev_mstr/portvision_dx).

**Note:** Depending on your operating system, you may need to respond to a Security Warning to permit access.

2. Execute the `PortVision_DX[version].msi` file.
3. Click **Next** on the *Welcome* screen.

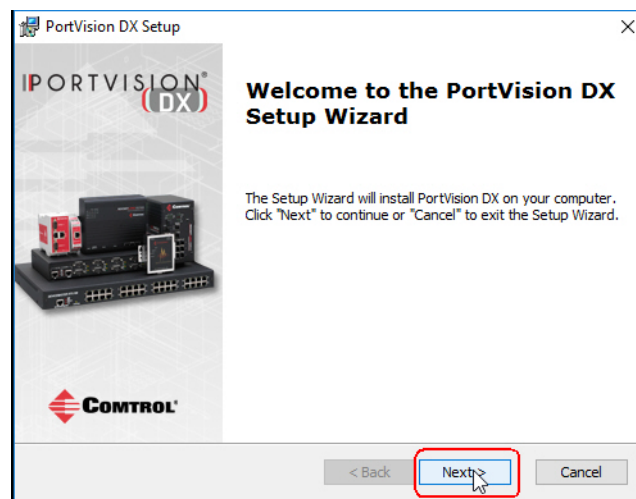

- Click **I accept the terms in the License Agreement and Next**.

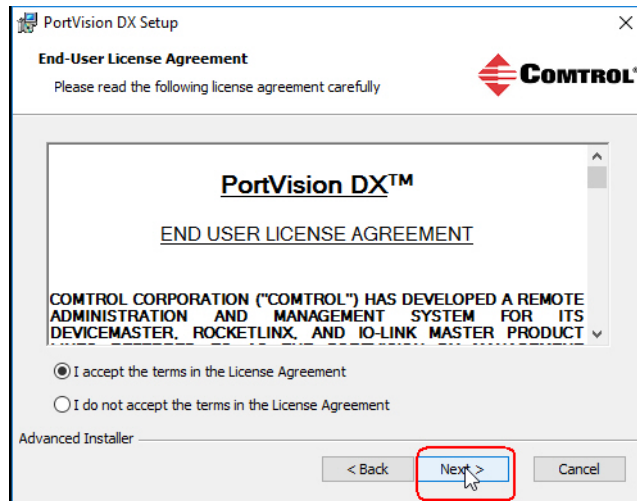

- Click **Next** or optionally, browse to a different location and then click **Next**.

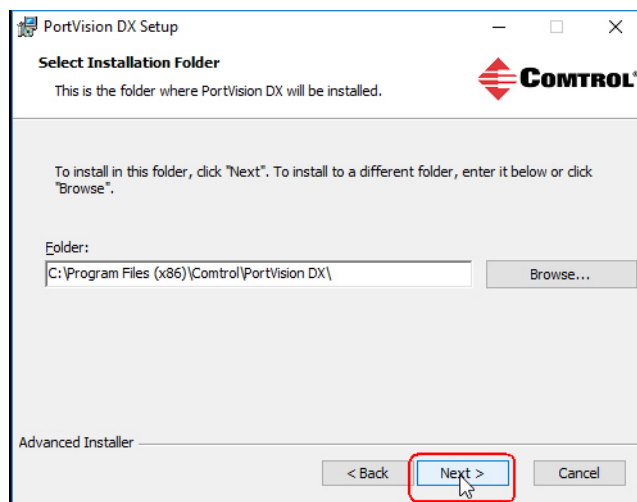

- Click **Next** to configure the shortcuts.

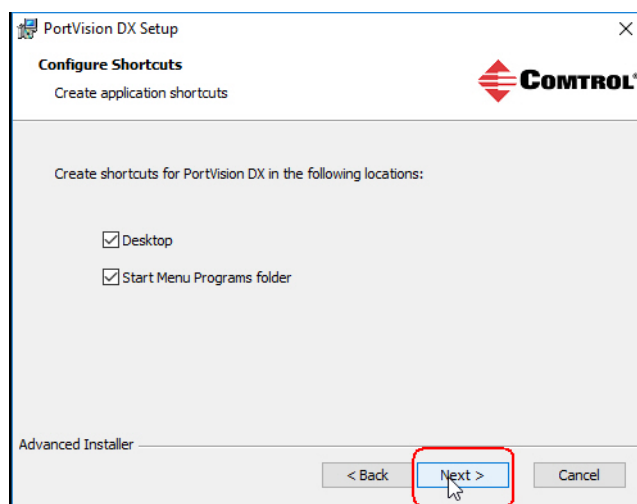



7. Click **Install**.

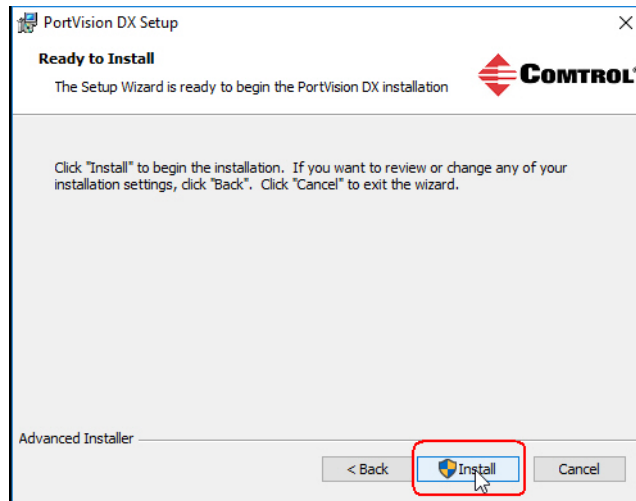

- 8. Depending on the operating system, you may need to click **Yes** to the *Do you want to allow the following program to install software on this computer?* query.
- 9. Click **Launch PortVision DX** and **Finish** in the last installation screen.

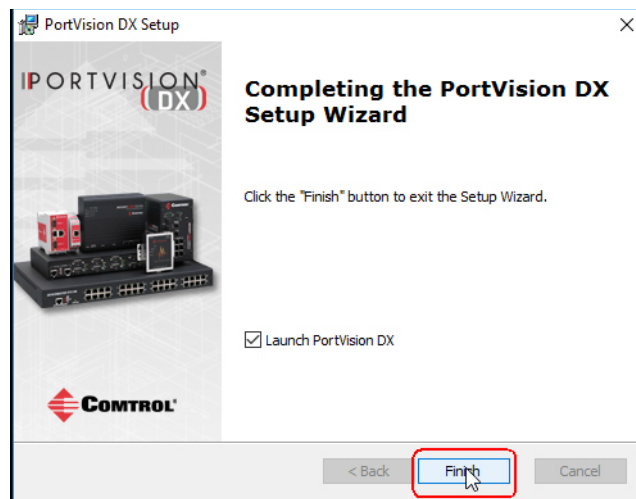

- 10. Depending on the operating system, you may need to click **Yes** to the *Do you want to allow the following program to make changes to this computer?* query.
- 11. Select the Control Ethernet-attached products that you want to locate and then click **Scan**. *You can save time if you only scan for DeviceMasters.*

**Note:** *If the Control Ethernet-attached product is not on the local segment and it has been programmed with an IP address, it will be necessary to manually add the Control Ethernet-attached product to PortVision DX.*

- 12. Go to [Step 5](#) in the next section, *Configuring the Network Settings*, to program the DeviceMaster network settings.

If you need additional information about PortVision DX, refer to the **Help** system.

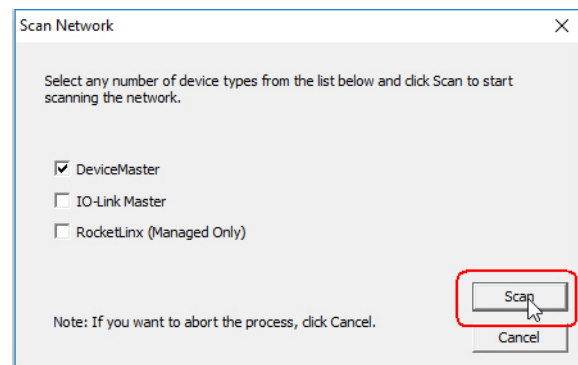



## Configuring the Network Settings

Use the following procedure to change the default network settings on the DeviceMaster for your network. The default network settings are;

- IP address: 192.168.250.250
- Subnet mask: 255.255.0.0
- Gateway address: 192.168.250.1

**Note:** *Technical Support advises configuring one new DeviceMaster at a time to avoid device driver configuration problems. If you want to configure multiple DeviceMasters using the **Assign IP to Multiple Devices** option, see [Configuring Multiple DeviceMasters Network Addresses](#) on Page 53.*

The following procedure shows how to configure a single DeviceMaster connected to the same network segment as the Windows system. If the DeviceMaster is not on the same physical segment, you can add it manually using [Adding a New Device in PortVision DX](#) on Page 53.

1. If you have not done so, install PortVision DX ([Installing PortVision DX](#) on Page 22).
2. Start PortVision DX using the **PortVision DX** desktop shortcut or from the **Start** button, click **Control > PortVision DX**.
3. Depending on your operating system, you may need to click **Yes** to the *Do you want to allow the following program to make changes to this computer?* query.
4. Click **Scan** to locate the Control Ethernet-attached products including the DeviceMaster on the network.

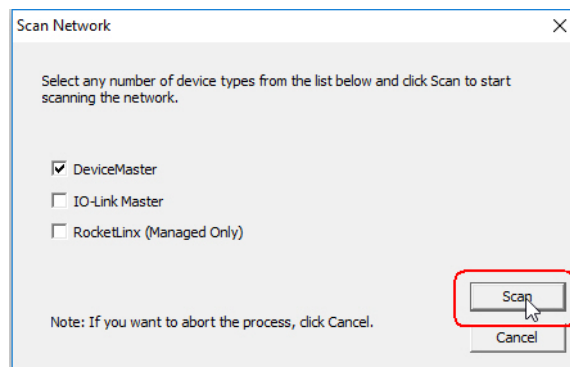

**Note:** *If you do not have any RocketLink managed switches or IO-Link Masters, it saves scanning time if you do not scan for them.*

5. Highlight the DeviceMaster for which you want to program network information and open the **Properties** screen using one of these methods.
  - Double-click the DeviceMaster in the *Device Tree* or *Device List* pane.
  - Right-click the DeviceMaster in the *Device Tree* or *Device List* pane and click **Properties** in the popup menu
  - Highlight the DeviceMaster in the *Device Tree* or *Device List* pane and click the **Properties** button.

- Highlight the DeviceMaster, click the **Manage** menu and then **Properties**.

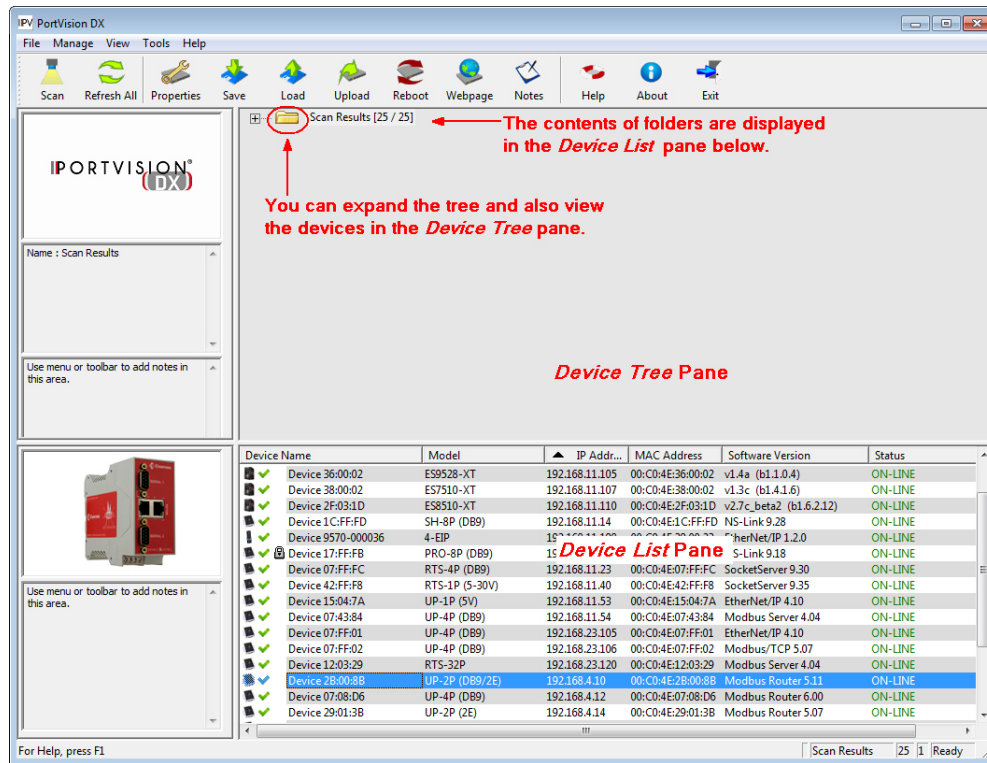

6. *Optionally*, rename the DeviceMaster in the **Device Name** field.

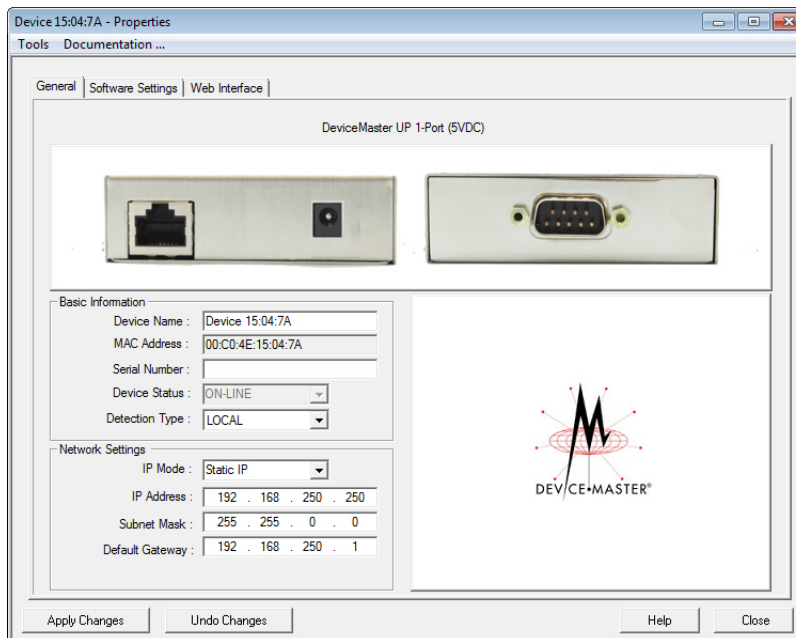

**Note:** The MAC address Device Status fields are automatically populated and you cannot change those values.

7. *Optionally*, enter the serial number, which is on a label on the DeviceMaster.
8. If necessary, you can change the **Detection Type**.
  - **REMOTE** means that the DeviceMaster is not connected to this segment of the network and it uses IP communications, not MAC communications.

- **LOCAL** means that the DeviceMaster is on this local network segment and uses MAC communications. An IP address is not required but Technical support recommends using an IP address.
9. Change the DeviceMaster network properties as required for your site.

<b>Disable IP</b>	Do not use this option. The DeviceMaster does not support using the MAC addressing scheme.
<b>DHCP IP†</b>	Click this option if you want to use the DeviceMaster with DHCP. Make sure that you provide the MAC address of the DeviceMaster to the network administrator.
<b>Static IP†</b>	Click this option to program a static IP address and type the appropriate IP address, subnet mask, and default gateway values for your site in the provided boxes.

**Note:** For additional information, open the *PortVision DX Help* system.

10. Click **Apply Changes** to update the network information on the DeviceMaster.
11. Click **Close** to exit the *Properties* window.
12. If applicable, check your firmware version to make sure that it is the latest version using the next subsection, [Checking the Protocol Firmware Version](#).
13. If necessary, use [Uploading Protocol-Specific Firmware on the DeviceMaster](#) on Page 29 to update or load the firmware for your DeviceMaster.

## Checking the Protocol Firmware Version

Use PortVision DX to check the firmware version before configuring the ports.

Depending on the model you purchased, the DeviceMaster may or may not have the protocol firmware loaded.

**Note:** Models that have a protocol loaded on the DeviceMaster are identified in PortVision DX and the DeviceMaster is labeled accordingly.

The following procedure shows how to use PortVision DX to check the firmware version on the DeviceMaster and check for the latest files.

**Note:** If you have not done so, install PortVision DX ([Installing PortVision DX](#) on Page 22).

1. Start PortVision DX by double-clicking the PortVision DX desktop icon or click **Control > PortVision DX**.
2. Examine the *List View* pane to see if or/and what version of the firmware is loaded on the DeviceMaster. If you see SocketServer or NS-Link as the *Software Version*, you must load the appropriate firmware for your protocol.

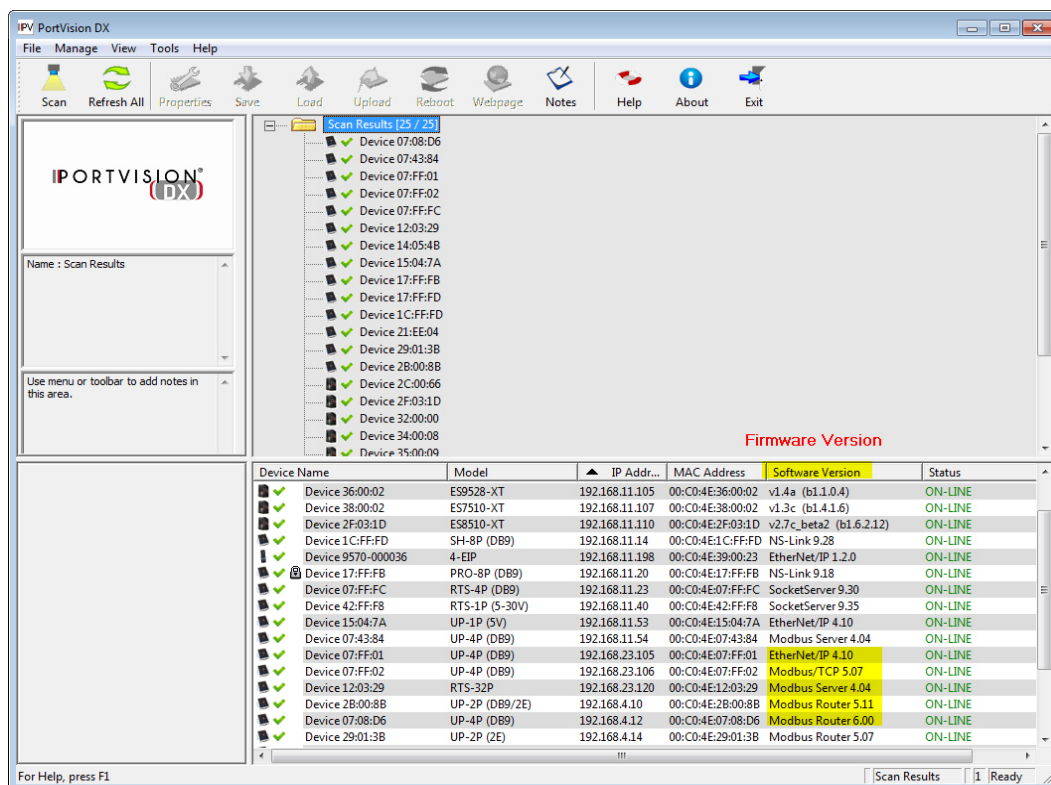

3. Check the Control FTP site to see if there is a later version available:  
[http://downloads.comtrol.com/html/DM\\_UP\\_main.htm](http://downloads.comtrol.com/html/DM_UP_main.htm).
4. If applicable, download the latest version and go to [Step 3](#) in [Uploading Protocol-Specific Firmware on the DeviceMaster](#) on Page 29.

## Uploading Protocol-Specific Firmware on the DeviceMaster

Some DeviceMaster models come from the factory with SocketServer firmware, which provides an interface to TCP/IP socket mode configuration and services, installed on the device.

If your DeviceMaster contains SocketServer and you want to configure one of the following environments, you must replace SocketServer with protocol-specific firmware.

You can download the latest firmware and corresponding documentation for your protocol from the download site:

[http://downloads.comtrol.com/html/DM\\_UP\\_Main.htm](http://downloads.comtrol.com/html/DM_UP_Main.htm).

If necessary, use the following procedure to update the firmware on your DeviceMaster for the appropriate protocol. See [Locating Software and Documentation](#) on Page 8, if you need to download the .msi file for your protocol.

**Note:** If you have not done so, install PortVision DX ([Installing PortVision DX](#) on Page 22) and install the firmware.msi file.

1. Execute the .msi file that you downloaded for the firmware.
2. Start PortVision DX by double-clicking the PortVision DX desktop icon or click **Control > PortVision DX**.
3. Right-click the device or devices for which you want to upload firmware and click the **Advanced > Upload Firmware** menu option.

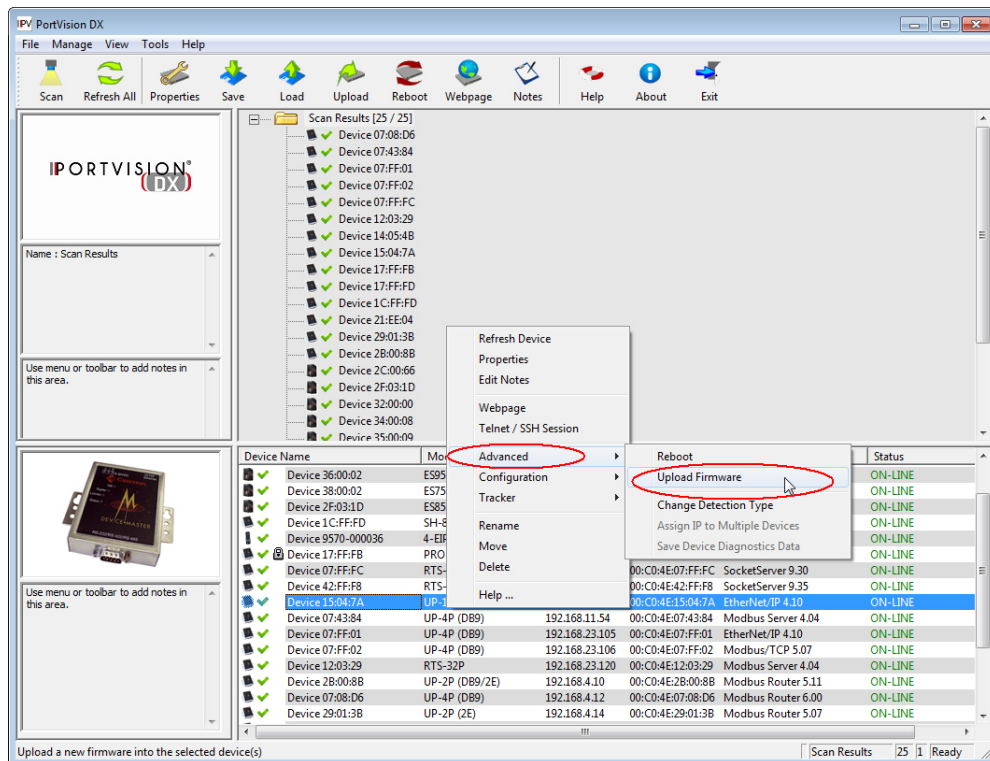

**Note:** Optionally, you can highlight a device and use the **Load** button.

4. Browse and select the protocol firmware (.cmtl) file and click **Open**.

- Click **Yes** to upload the firmware.

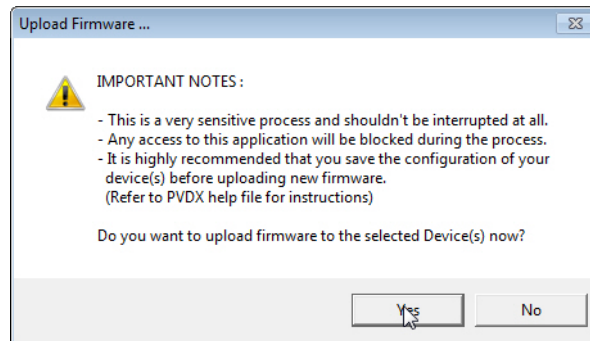

- Click **OK** to the advisory message about waiting until the DeviceMaster is on-line and in the next minute the DeviceMaster unit or units should display **ON-LINE** in the **Status** field.

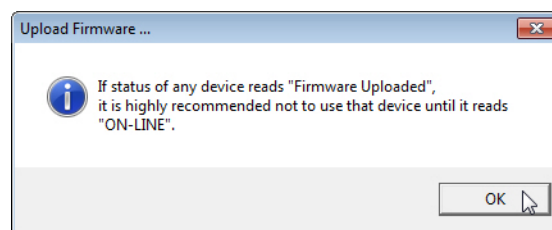

- Go to the appropriate *Quick Start* or *User Guide* for your protocol for information about configuring the serial port or ports using the web page and programming your PLCs. See [Locating Software and Documentation](#) on Page 8 to locate the document for your protocol.

If you are planning on installing multiple DeviceMasters, you may want to use the *Save / Load Configuration File* feature in PortVision DX.

A configuration file can contain network settings and protocol settings. Refer to the PortVision DX help system for information about saving and loading configuration files.

- After configuring the serial port characteristics and preparing your PLC programs, you can use the next section in this guide, to attach the serial device or devices.

## Customizing PortVision DX

You can customize how PortVision DX displays the devices. You can even create sessions tailored for specific audiences. You can also add shortcuts to other applications using **Tools > Applications > Customize** feature.

The following illustrates how you can customize your view.

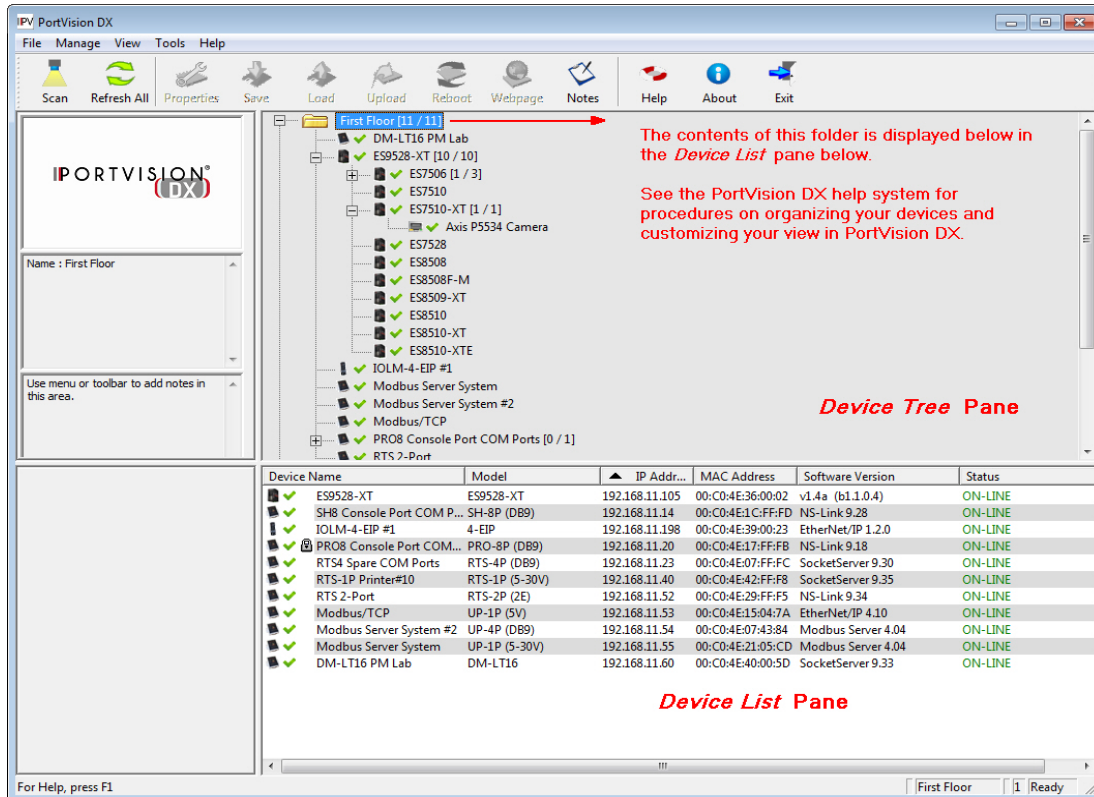

See the PortVision DX Help system for detailed information about modifying the view. For example, the above screen shot illustrates devices layered in folders.



## Accessing DeviceMaster Documentation from PortVision DX

You can use this procedure in PortVision DX to [download](#) and [open the previously downloaded documents](#) for the DeviceMaster. You can also check to see if you have the latest version of the documentation using PortVision DX.

### How to Download Documentation

Use this procedure to initially download a document or documents.

1. If necessary, open **Control > PortVision DX** or use the desktop shortcut.
2. Click **Help > Documentation**.
3. Optionally, click the **DOWNLOAD THE CURRENT DOCUMENTATION CATALOG ONLINE** button to make sure that the latest documentation is available to PortVision DX.

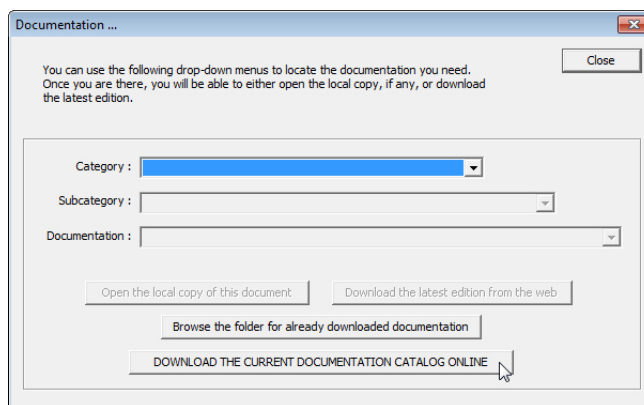
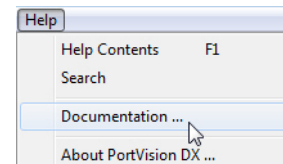

4. Select the product **Category** from the drop list.
5. Select the document you want to download from the **Documentation** drop list.
6. Click the **Download the latest edition from the web** button.

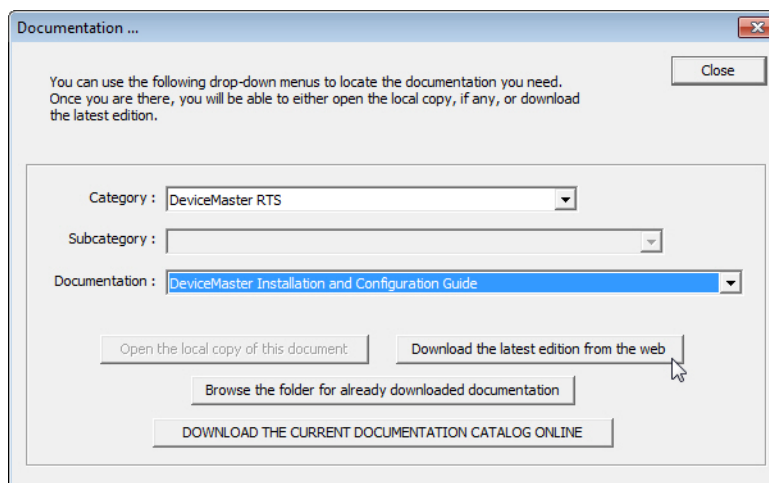

**Note:** It may take a few minutes to download, depending on your connection speed. The document opens automatically after it has downloaded.

7. Click **Close** if you have downloaded all of the documents that you wanted.



## How to Open Previously Downloaded Documents

Use the following procedure to access previously downloaded documents in PortVision DX.

**Note:** *Optionally, you can browse to the **Program Files (x86) > Control > PortVision DX > Docs** subdirectory and open the document.*

1. If necessary, open **Control > PortVision DX** or use the desktop shortcut.
2. Click **Help > Documentation**.
3. Click the **Open the local copy of the document** button to view the document.

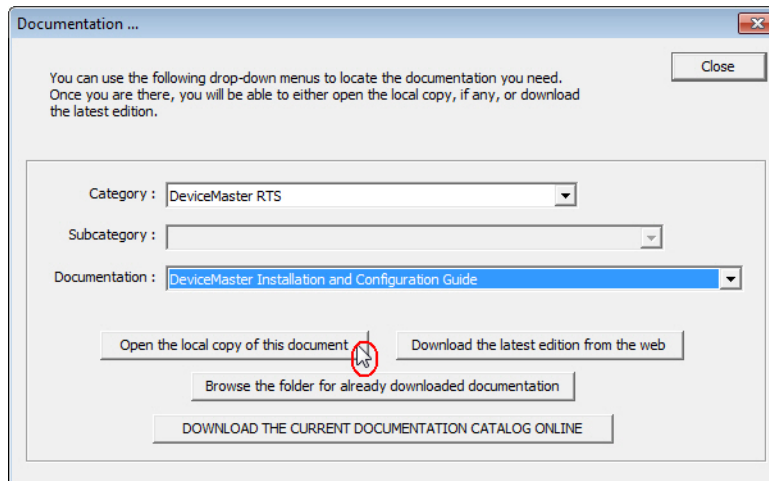

**Note:** *If the document fails to open, it may be that your browser has been disabled. You can still access the document by clicking the **Browse the folder for already downloaded documentation** button and opening the document with your custom browser.*

4. Click **Close** in the *Documentation...* popup, unless you want to open or download other documents.



# Connecting Serial Devices

This section discusses connecting your serial devices to the DeviceMaster. It also provides you with information to build serial cables and loopback connectors to test the serial ports.

- [DB9 Connectors](#)
- [RJ45 Connectors](#) on Page 39
- [Four Screw Terminals \(EIP-2202\)](#) on Page 42
- [Eight Screw Terminals \(EIP-2402\)](#) on Page 45
- [Nine Screw Terminals \(EIP-2201\)](#) on Page 48



**Make sure that you have configured the ports for the correct communications mode before connecting any devices. The default mode is RS-232. There is a remote possibility that connecting a serial device for the wrong mode could damage the serial device.**

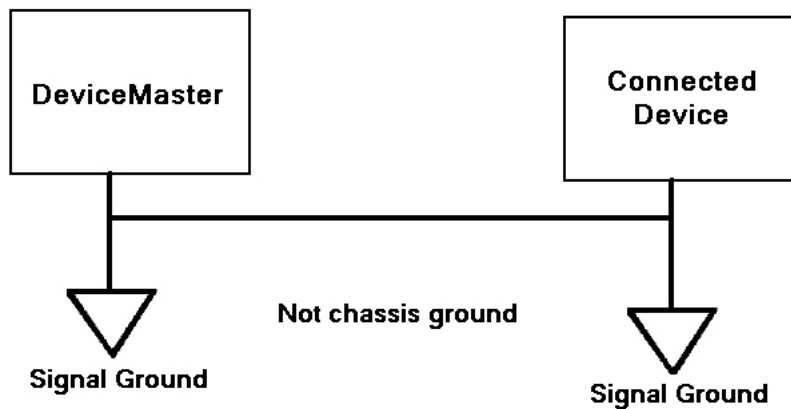

## DB9 Connectors

This subsection provides the following information:

- Connector pin assignments (below)
- [DB9 Null-Modem Cables \(RS-232\)](#) on Page 37
- [DB9 Null-Modem Cables \(RS-422\)](#) on Page 37
- [DB9 Straight-Through Cables \(RS-232/485\)](#) on Page 37
- [DB9 Loopback Plugs](#) on Page 38
- [Connecting DB9 Serial Devices](#) on Page 38

<b>DB9 Connector Pin Outs</b>			
<b>Pin</b>	<b>RS-232</b>	<b>RS-422 and RS-485 Full-Duplex (Master/Slave)†</b>	<b>RS-485 Half-Duplex</b>
1	DCD	Not used	Not used
2	RxD	RxD-	Not used
3	TxD	TxD-	TRxD-
4	DTR	Not used	Not used
5	Signal GND	Signal GND	Signal GND
6	DSR	Not used	Not used
7	RTS	TxD+	TRxD+
8	CTS	RxD+	Not used
9	RI	Not used	Not Used
† The following models support RS-485 full-duplex: <ul style="list-style-type: none"> <li>• 1-Port DIN rail models</li> <li>• 2-Port DIN rail models</li> <li>• 4-Port DIN rail models</li> </ul>			

Refer to the hardware manufacturer’s installation documentation if you need help with connector pin outs or cabling for the serial device. This illustrates the DB9 connector signals.

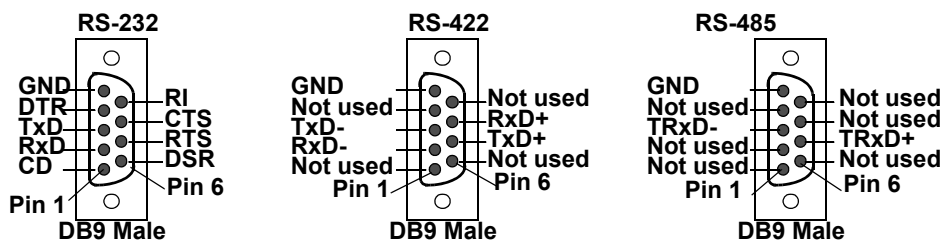

### DB9 Null-Modem Cables (RS-232)

Use the following figure if you need to build an RS-232 null-modem cable. A null-modem cable is required for connecting DTE devices.

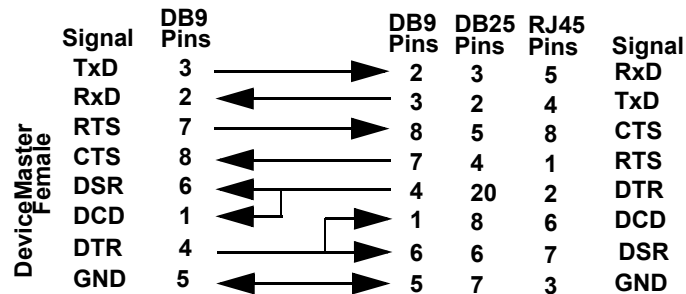

**Note:** You may want to purchase or build a straight-through cable and purchase a null-modem adapter.

### DB9 Null-Modem Cables (RS-422)

Use the following figure if you need to build an RS-422 null-modem cable.

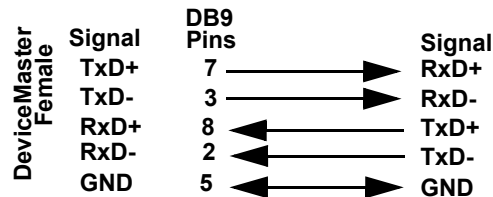

**Note:** RS-422 pin outs are not standardized. Each peripheral manufacturer uses different pin outs. Refer to the peripheral documentation to determine the pin outs for the signals above.

### DB9 Straight-Through Cables (RS-232/485)

Use the following figure if you need to build an RS-232 or RS-485 straight-through cable. Straight-through cables are used to connect modems and other DCE devices. For example, a straight-through cable can be used to connect COM2 to a modem.

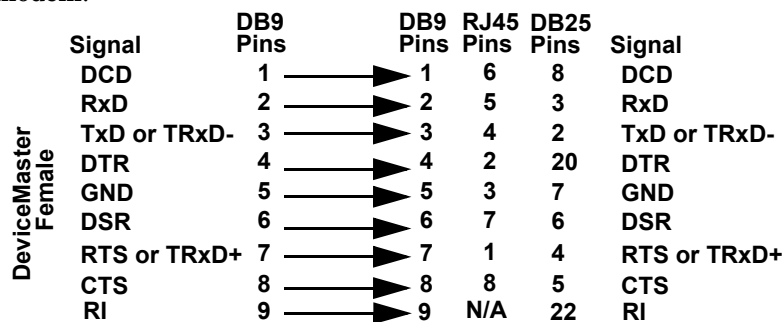

## DB9 Loopback Plugs

*Loopback connectors* are DB9 female serial port plugs with pins wired together that are used in conjunction with application software to test serial ports. The DeviceMaster is shipped with a single loopback plug (RS-232/422).

Not all DeviceMaster protocols provide test (example programs). Refer to the [EtherNet/IP User Guide](#) for information about using those example programs.

Wire the following pins together to build additional plugs or replace a missing RS-232 loopback plug:

- Pins 1 to 4 to 6
- Pins 2 to 3
- Pins 7 to 8 to 9



Wire the following pins together for an RS-422 loopback plug:

- Pins 2 to 3
- Pins 7 to 8



## Connecting DB9 Serial Devices

You can use this information to connect serial devices to DB9 connectors.

1. Connect your serial devices to the appropriate serial port on the DeviceMaster using the appropriate cable.

**Note:** Refer to the hardware manufacturer's installation documentation if you need help with connector pin outs or cabling for the peripheral device.

2. DeviceMaster 4-port: verify that the devices are communicating properly.

**Note:** DeviceMaster 1-port, 2-port models, and the 4-port DIN models do not have TX/RX LEDs.



The RX (yellow) and TX (green) LEDs function accordingly when the cable is attached properly to a serial device. \* Represents port number.

- After power cycling the DeviceMaster (appropriate models), the RX/TX LEDs are off.
  - The LEDs do not function as described until the port has been opened by an application.
3. You can refer to [Network and Device LEDs](#) on Page 83 for information about the remaining LEDs.

## RJ45 Connectors

This subsection provides the following information:

- Connector pin assignments (below)
- [RJ45 Null-Modem Cables \(RS-232\)](#)
- [RJ45 Null-Modem Cables \(RS-422\)](#) on Page 40
- [RJ45 Straight-Through Cables \(RS-232/485\)](#) on Page 40
- [RJ45 Loopback Plugs](#) on Page 40
- [RJ45 RS-485 Test Cable](#) on Page 40
- [Connecting RJ45 Devices](#) on Page 41

You can build your own null-modem or straight-through RJ45 serial cables if you are using the DB9 to RJ45 adapters using the following subsections.

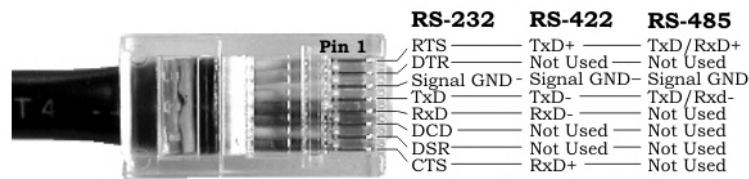

Pin	RS-232	RS-422	RS-485
1	RTS	TxD+	TRxD+
2	DTR	Not used	Not used
3	Signal GND	Signal GND	Signal GND
4	TxD	TxD-	TRxD-
5	RxD	RxD-	Not used
6	DCD	Not used	Not used
7	DSR	Not used	Not used
8	CTS	RxD+	Not used

### RJ45 Null-Modem Cables (RS-232)

Use the following figure if you need to build an RS-232 null-modem cable. A null-modem cable is required for connecting DTE devices.

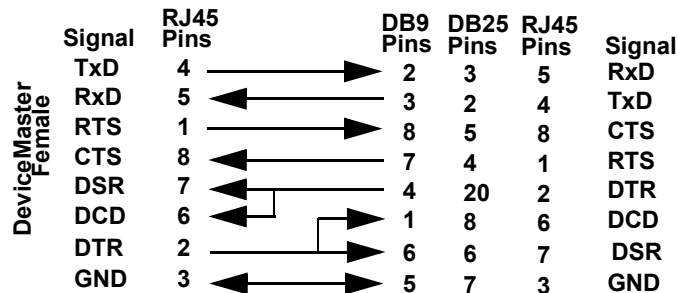

**Note:** You may want to purchase or build a straight-through cable and purchase a null-modem adapter. For example, a null-modem cable can be used to connect COM2 of one PC to COM2 of another PC.

### RJ45 Null-Modem Cables (RS-422)

Use the following figure if you need to build an RS-422 null-modem RJ45 cable. A null-modem cable is required for connecting DTE devices.

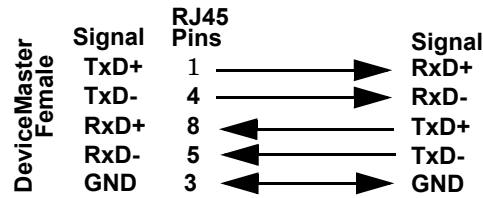

**Note:** RS-422 pin outs are not standardized. Each peripheral manufacturer uses different pin outs. Please refer to the documentation for the peripheral to determine the pin outs for the signals above.

### RJ45 Straight-Through Cables (RS-232/485)

Use the following figure if you need to build an RS-232 or RS-485 straight-through cable. Straight-through cables are used to connect modems and other DCE devices. For example, a straight-through cable can be used to connect COM2 of one PC to COM2 to a modem.

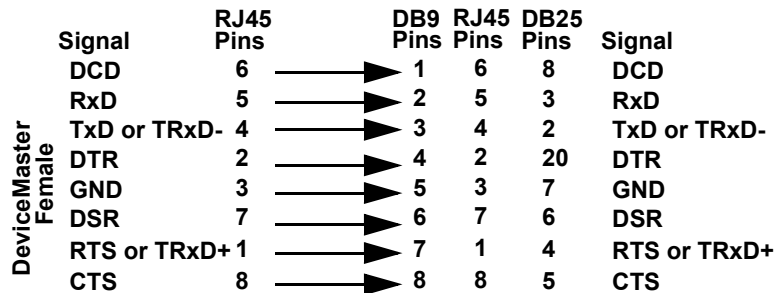

### RJ45 Loopback Plugs

Loopback connectors are RJ45 serial port plugs with pins wired together that are used in conjunction with application software to test serial ports. The DeviceMaster is shipped with a single loopback plug (RS-232/422).

- Pins 4 to 5
- Pins 1 to 8
- Pins 2 to 6 to 7

Not all DeviceMaster protocols provide test (example programs). Refer to the [EtherNet/IP User Guide](#) for information about using those example programs.

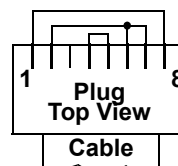

The RS-232 loopback plug also works for RS-422.

### RJ45 RS-485 Test Cable

You can use a straight-through cable as illustrated previously, or build your own cable.

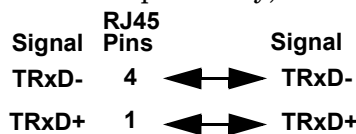

**Note:** RS-422 pin outs are not standardized. Each peripheral manufacturer uses different pin outs. Please refer to the documentation for the peripheral to determine the pin outs for the signals above.



---

## Connecting RJ45 Devices

---

You can use this information to connect serial devices to RJ45 connectors.

1. Connect your serial devices to the appropriate serial port on the DeviceMaster using the appropriate cable.

**Note:** Refer to the hardware manufacturer's installation documentation if you need help with connector pin outs or cabling for the peripheral device.

2. If the DeviceMaster has RX/TX LEDs, verify that the devices are communicating properly.

The RX (yellow) and TX (green) LEDs function accordingly when the cable is attached properly to a serial device.

- After power cycling the DeviceMaster, the RX/TX LEDs are off.
  - The LEDs do not function as described until the port has been opened by an application.
3. You can refer to [Network and Device LEDs](#) on Page 83 for information about the remaining LEDs.

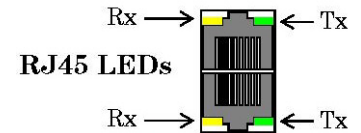

## Four Screw Terminals (EIP-2202)

This subsection discusses the following topics for the EIP-2202 with 4 serial screw terminals. See [Eight Screw Terminals \(EIP-2402\)](#) on Page 45 if the DeviceMaster has eight serial terminals.

- [Serial Terminal \(4\) Connectors](#) on Page 42
- [Serial Terminal \(4\) Null-Modem Cables \(RS-232\)](#) on Page 43
- [Serial Terminal \(4\) Null-Modem Cables \(RS-422\)](#) on Page 43
- [Serial Terminal \(4\) Straight-Through Cables \(RS-232/485\)](#) on Page 44
- [Serial Terminal \(4\) Loopback Signals](#) on Page 44
- [Connecting Serial Devices](#) on Page 44

### Serial Terminal (4) Connectors

Use the following table or drawings for signal information. The signals for SERIAL2 are the same as SERIAL1.

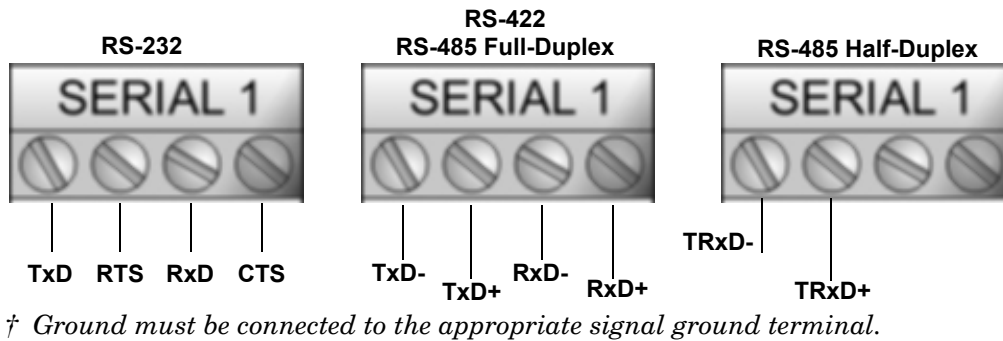

#### RS-232: Connecting the Ground

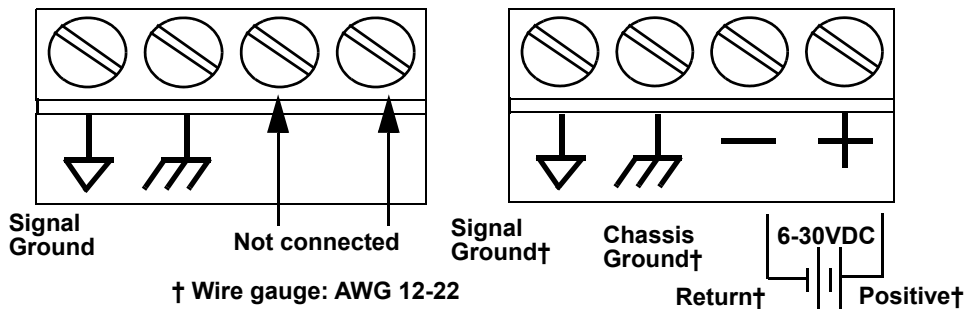

<b>RS-232†</b>	TxD	RTS	RxD	CTS
<b>RS-422/RS-485 Full-Duplex</b>	TxD-	TxD+	RxD-	RxD+
<b>RS-485 Half-Duplex</b>	TRxD-	TRxD+		

† RS-232 ground must be connected to the signal ground terminal.

### Serial Terminal (4) Null-Modem Cables (RS-232)

An RS-232 null-modem cable is required for connecting DTE devices.

RS-232 Null-Modem Cable

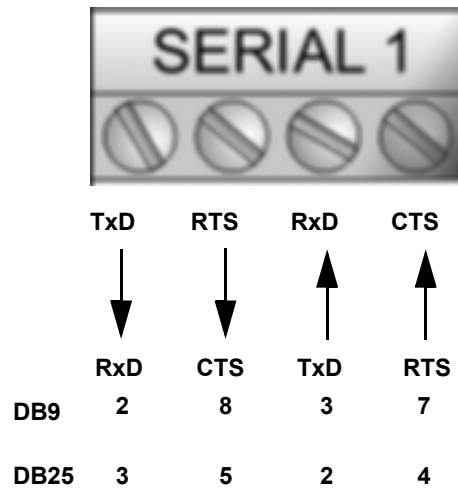

### Serial Terminal (4) Null-Modem Cables (RS-422)

An RS-422 null-modem cable is required for connecting DTE devices.

RS-422 Null-Modem Cable

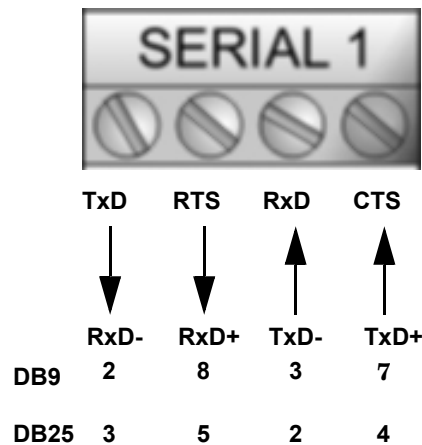

**Note:** RS-422 pin outs are not standardized. Each peripheral manufacturer uses different pin outs. Please refer to the documentation for the peripheral to determine the pin outs for the signals above.

### Serial Terminal (4) Straight-Through Cables (RS-232/485)

---

RS-232 or RS-485 straight-through cables are used to connect modems and other DCE devices.

#### RS-232/422 Straight-Through Cable

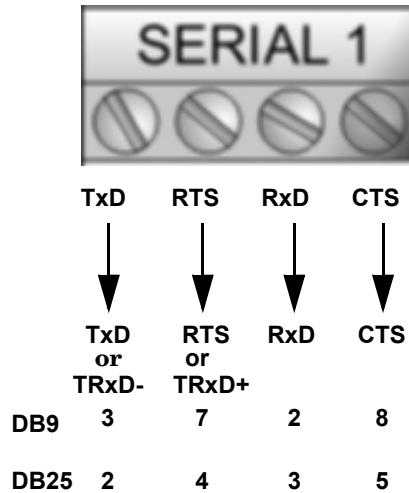

### Serial Terminal (4) Loopback Signals

---

Use this drawing to wire a loopback, which is used in conjunction with application software (Test Terminal for Windows or minicom for Linux) to test serial ports.

Wire the terminals together to create a loopback.

- TxD to RxD
- RTS to CTS

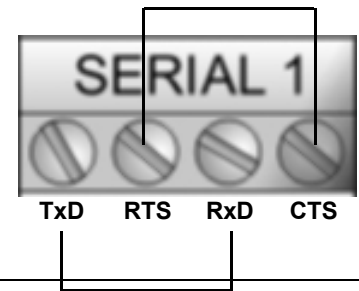

### Connecting Serial Devices

---

Use the following information to connect the EIP-2202 with serial terminals.

1. Connect your serial devices to the appropriate serial port on the EIP-2202 using the appropriate cable. You can build your own cables or loopbacks using the appropriate discussions.

**Note:** Refer to the hardware manufacturer's installation documentation if you need help with connector pin outs or cabling for the serial device.

2. You can refer to [Network and Device LEDs](#) on Page 83 for information about the LEDs.

## Eight Screw Terminals (EIP-2402)

This subsection discusses the following topics for the DeviceMaster with 8 serial screw terminals.

- [Screw Terminal \(8\) Connectors](#) on Page 45
- [Screw Terminal \(8\) Null-Modem Cables \(RS-232\)](#) on Page 46
- [Screw Terminal \(8\) Null-Modem Cables \(RS-422\)](#) on Page 46
- [Screw Terminal \(8\) Straight-Through Cables \(RS-232/485\)](#) on Page 47
- [Screw Terminal \(8\) Loopback Signals](#) on Page 47
- [Connecting Serial Devices](#) on Page 47

### Screw Terminal (8) Connectors

Use the following drawings or table for signal information. The signals for SERIAL2 are the same as SERIAL1.

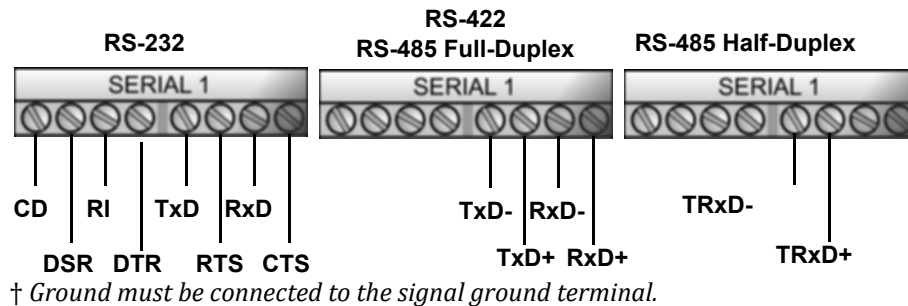

#### RS-232: Connecting the Ground

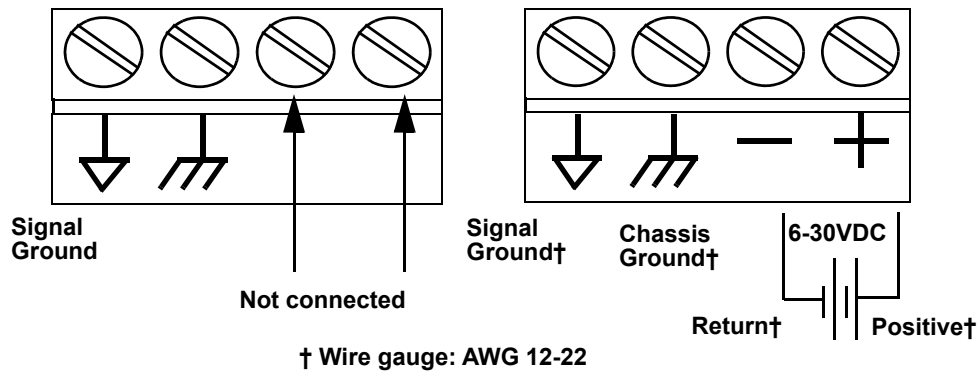

RS-232	CD	DSR	RI	DTR	TxD	RTS	RxD	CTS
<b>RS-422/RS-485 Full-Duplex</b>	N/A	N/A	N/A	N/A	TxD-	TxD+	RxD-	RxD+
<b>RS-485 Half-Duplex</b>	N/A	N/A	N/A	N/A	TRxD-	TRxD+	N/A	N/A

† Ground must be connected to the appropriate signal ground terminal.

### Screw Terminal (8) Null-Modem Cables (RS-232)

---

An RS-232 null-modem cable is required for connecting DTE devices.

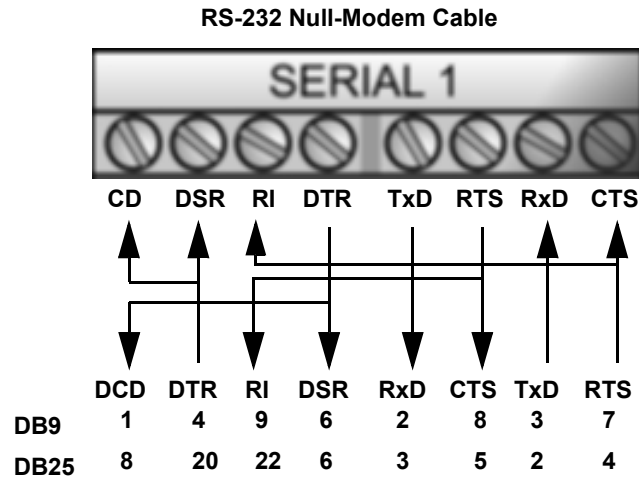

### Screw Terminal (8) Null-Modem Cables (RS-422)

---

An RS-422 null-modem cable is required for connecting DTE devices.

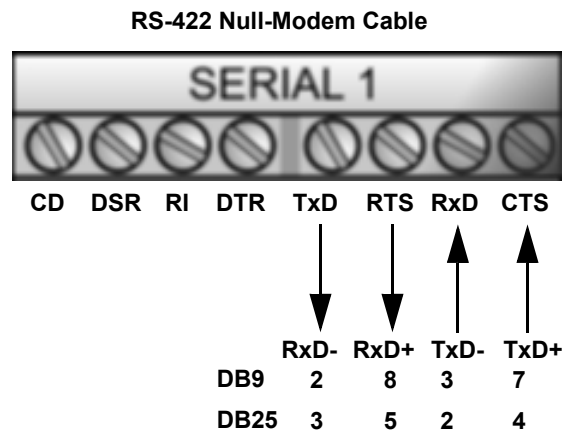

## Screw Terminal (8) Straight-Through Cables (RS-232/485)

RS-232 or RS-485 straight-through cables are used to connect modems and other DCE devices.

RS-232/485 Straight-Through Cable

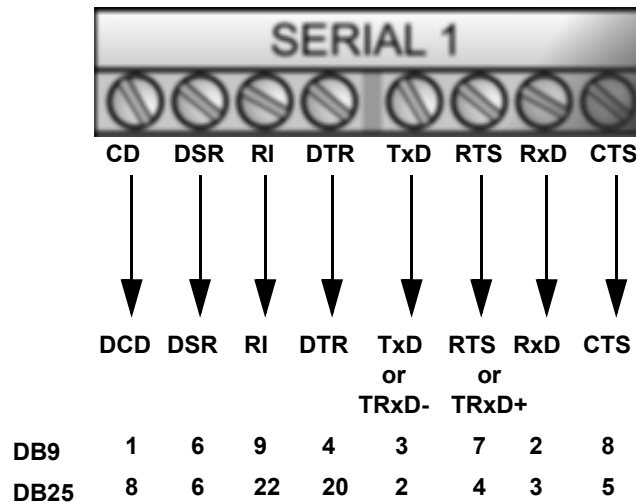

## Screw Terminal (8) Loopback Signals

Use the drawing below to wire a loopback, which is used in conjunction with application software to test serial ports.

Wire the terminals together to create a loopback.

- TxD to RxD
- RTS to CTS to RI
- DTR to CD to DSR

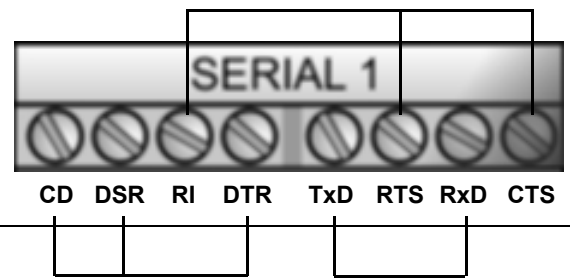

## Connecting Serial Devices

Use the following information to connect the DeviceMaster with 8 serial screw terminals.

1. Connect your serial devices to the appropriate serial port on the DeviceMaster using the appropriate cable.

**Note:** Refer to the hardware manufacturer's installation documentation if you need help with connector pin outs or cabling for the serial device.

2. You can refer to [Network and Device LEDs](#) on Page 83 for information about the LEDs.

## Nine Screw Terminals (EIP-2201)

This subsection discusses the following topics for the EIP-2201 with 9 serial screw terminals.

- [Screw Terminal Connectors \(9\)](#) on Page 48
- [Screw Terminal \(9\) Null-Modem RS-232 Cables](#) on Page 48
- [Screw Terminal \(9\) Null-Modem RS-422 Cables](#) on Page 49
- [Screw Terminal \(9\) RS-232/485 Straight-Through Cables](#) on Page 49
- [Screw Terminal \(9\) Loopback Signals](#) on Page 50
- [Connecting Serial Devices](#) on Page 50

### Screw Terminal Connectors (9)

Use the following table or drawings for signal information.

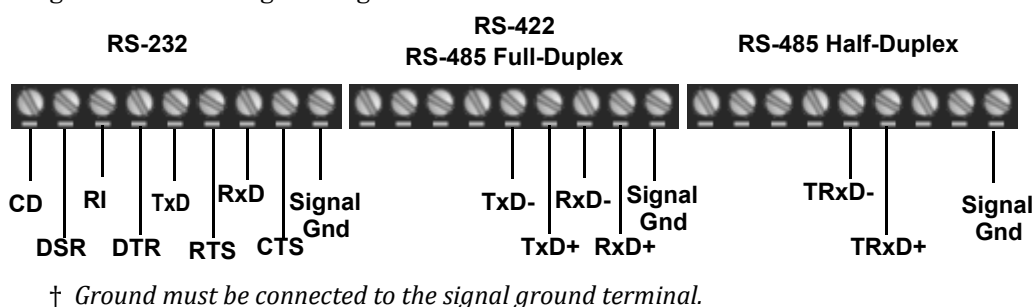

<b>RS-232</b>	CD	DSR	RI	DTR	TxD	RTS	RxD	CTS	Signal GND
<b>RS-422/RS-485 Full-Duplex</b>	N/A	N/A	N/A	N/A	TxD-	TxD+	RxD-	RxD+	Signal GND
<b>RS-485 Half-Duplex</b>	N/A	N/A	N/A	N/A	TRxD-	TRxD+	N/A	N/A	Signal GND

† Ground must be connected to the signal ground terminal.

### Screw Terminal (9) Null-Modem RS-232 Cables

An RS-232 null-modem cable is required for connecting DTE devices.

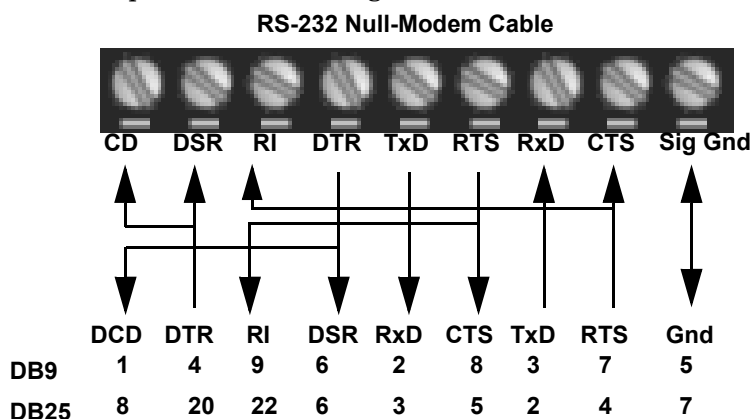



### Screw Terminal (9) Null-Modem RS-422 Cables

An RS-422 null-modem cable is required for connecting DTE devices.

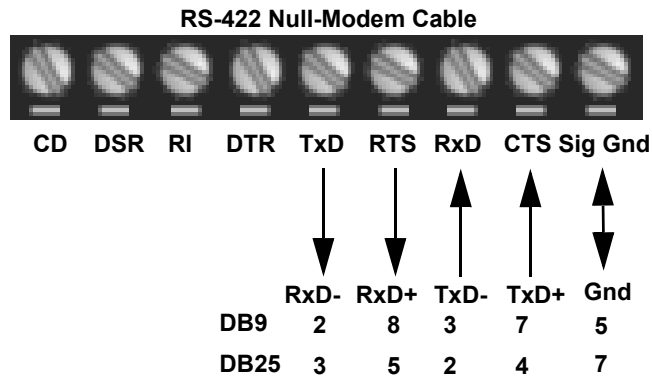

**Note:** RS-422 pin outs are not standardized. Each peripheral manufacturer uses different pin outs. Please refer to the documentation for the peripheral to determine the pin outs for the signals above.

### Screw Terminal (9) RS-232/485 Straight-Through Cables

RS-232 or RS-485 straight-through cables are used to connect modems and other DCE devices.

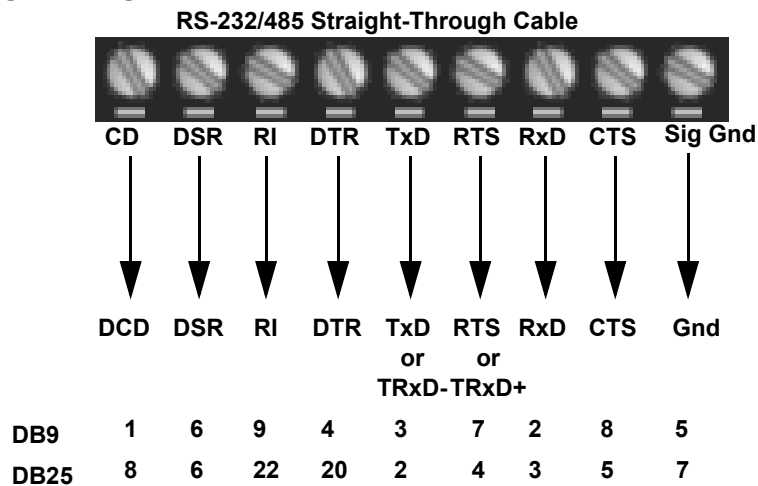

### Screw Terminal (9) Loopback Signals

---

Use this drawing to wire a loopback, which is used in conjunction with application software (Test Terminal for Windows or minicom for Linux) to test serial ports.



Wire the terminals together to create a loopback.

- TxD to RxD
- RTS to CTS to RI
- DTR to CD to DSR

### Connecting Serial Devices

---

Use the following information to connect the DeviceMaster with serial terminals.

1. Connect your serial devices to the appropriate serial port on the DeviceMaster using the appropriate cable. You can build your own cables or loopbacks using the appropriate discussions.

**Note:** Refer to the hardware manufacturer's installation documentation if you need help with connector pin outs or cabling for the serial device.

2. You can refer to [Network and Device LEDs](#) on Page 83 for information about the LEDs.

# Managing the DeviceMaster

This section discusses the following DeviceMaster maintenance procedures:

- [Rebooting the DeviceMaster](#)
  - [Uploading Firmware to Multiple DeviceMasters](#) on Page 52
  - [Configuring Multiple DeviceMasters Network Addresses](#) on Page 53
- Note:** You can configure the network addresses for multiple DeviceMasters, configure common settings for the DeviceMasters, and save the settings to a configuration file that you can use to load settings up to all or selected DeviceMasters.
- [Adding a New Device in PortVision DX](#) on Page 53
  - [Changing the Bootloader Timeout](#) on Page 55, which discusses changing the Bootloader timeout
  - [Managing Bootloader](#) on Page 59, which also discusses checking the Bootloader version and downloading the latest Bootloader
  - [Restoring Factory Defaults \(Specific Models - Reset Button\)](#) on Page 61
  - [Restoring Defaults](#) on Page 61
  - [Accessing RedBoot Commands in Telnet/SSH Sessions \(PortVision DX\)](#) on Page 62

**Note:** You can optionally refer to [RedBoot Procedures](#) on Page 65 if you want to perform procedures at the RedBoot level.

## Rebooting the DeviceMaster

---

---

There are many ways to reboot the DeviceMaster.

Method	Procedure
PortVision DX	Right-click the DeviceMaster or DeviceMasters in the <i>Device List</i> pane, click <b>Advanced &gt;Reboot</b> and then <b>Yes</b> . <b>Note:</b> If security has been enabled in the web page, you will need to reboot the DeviceMaster in the web page.
Web page	<b>System   Reboot:</b> You have 10 seconds to Cancel before the DeviceMaster automatically reboots. Optionally, you can click <b>Reboot Now</b> .
Telnet	Type <b>reset</b> .
DeviceMaster DIN Rail Models	DeviceMaster DIN rail models have a <b>Reset/Restore</b> switch. <ul style="list-style-type: none"><li>• If the <b>Reset/Restore</b> switch is depressed for less than 2 seconds, the DeviceMaster reboots.</li><li>• If the <b>Reset/Restore</b> switch is depressed for greater than approximately 5 seconds it restores the DeviceMaster to the factory default values.</li></ul>

## Uploading Firmware to Multiple DeviceMasters

You can use this procedure if your DeviceMaster is connected to the host PC, laptop, or if the DeviceMaster resides on the local network segment.

1. If you have not done so, install PortVision DX ([Installing PortVision DX](#) on Page 22) and **Scan** the network.
2. Shift-click the multiple DeviceMasters on the **Main** screen that you want to update and use one of the following methods:
  - Click the **Upload** button.
  - Right-click and then click **Advanced > Upload Firmware**.
  - Click **Advanced > Upload Firmware** in the **Manage** menu.

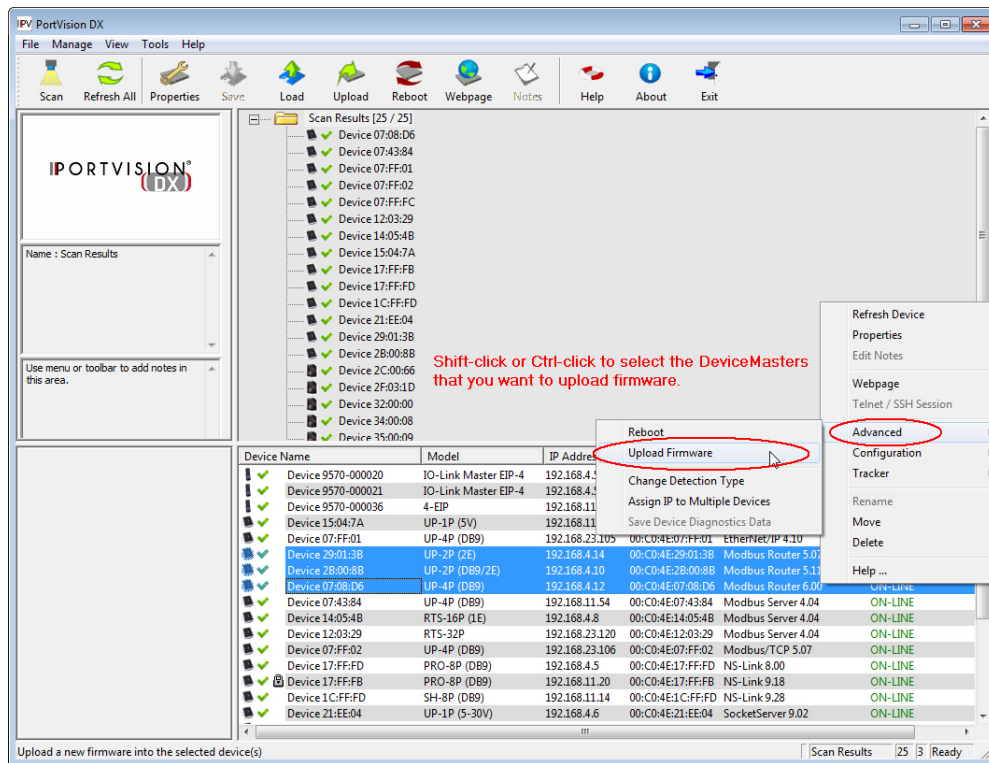

3. Browse, click the firmware (.cmtl) file, **Open** (*Please locate the new firmware*), and then click **Yes** (*Upload Firmware*).

It may take a few moments for the firmware to upload onto the DeviceMaster. The DeviceMaster reboots itself during the upload process.

4. Click **Ok** to the advisory message about waiting to use the device until the status reads **ON-LINE**.

In the next polling cycle, PortVision DX updates the *Device List* pane and displays the new firmware version.

## Configuring Multiple DeviceMasters Network Addresses

You can configure the network addresses for multiple DeviceMasters using the **Assign IP to Multiple Devices** option.

In addition, you can also configure common settings for the DeviceMaster web page and save the settings to a configuration file that you can load to all or selected DeviceMasters. See [Configuration File](#) on Page 124 for more information.

The DeviceMasters must be on the same network segment for this procedure to work. Use the following steps to configure multiple DeviceMasters.

1. If you have not done so, install PortVision DX ([Installing PortVision DX](#) on Page 22) and **Scan** the network.
2. Shift-click the DeviceMasters for which you want to program network information, right-click, and click **Advanced > Assign IP to Multiple Devices**.
3. Enter the starting IP address, subnet mask, IP Gateway and click **Proceed**.

PortVision DX displays the programmed IP addresses in the *Device List* pane after the next refresh cycle.

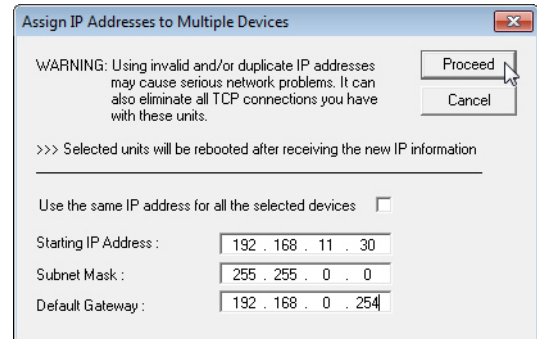

## Adding a New Device in PortVision DX

You can add a new DeviceMaster manually, if you do not want to scan the network to locate and add new DeviceMasters, but there may be cases where you want to use the *Add New Device* window to:

- Configure DeviceMaster units that are not on the local network (remote) using [Remote Using the IP Address](#) on Page 53.
- Pre-configure a DeviceMaster in PortVision DX (local) using [Local Using the IP Address or MAC Address](#) on Page 54.

### Remote Using the IP Address

Use the following procedure to add a remote DeviceMaster to PortVision DX.

1. Access the *New Device* window using one of these methods:
  - Click **Add New > Device** in the *Manage* menu.
  - Right-click a folder or a RocketLinx switch in the *Device Tree* pane (anywhere in the pane, as long as a DeviceMaster is not highlighted and you are in a valid folder) and click **Add New > Device**.
2. Select the appropriate DeviceMaster in the **Device Type** drop list.
3. Select the appropriate model in the **Device Model** drop list.
4. Enter a friendly device name in the **Device Name** list box.
5. Select **REMOTE** for the *Detection Type*.
6. Optionally, enter the serial number in the **Serial Number** list box.

7. Enter the IP Address for the DeviceMaster. It is not necessary to enter the Subnet Mask and Default Gateway.

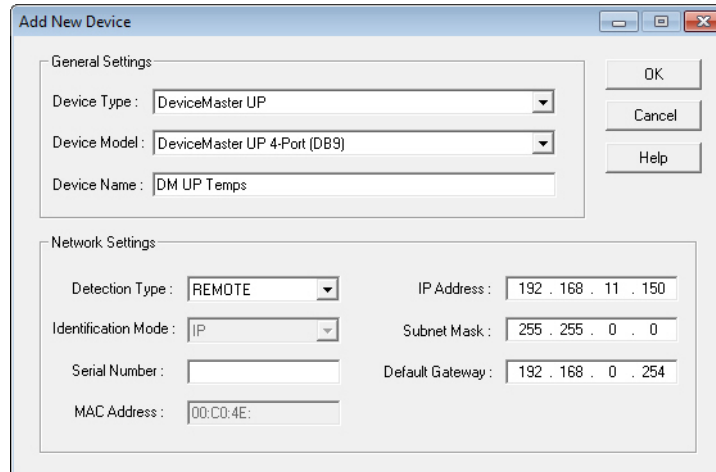

8. Click **Ok** to close the *Add New Device* window. It may take a few moments to save the DeviceMaster.
9. If necessary, click **Refresh** for the new DeviceMaster to display in the *Device Tree* or *Device List* panes. The DeviceMaster shows OFF-LINE if it is not attached to the network or if an incorrect IP address was entered.

### Local Using the IP Address or MAC Address

---

Use the following procedure to add a local DeviceMaster to PortVision DX if you do not want to scan the network.

1. Locate the network information or MAC address of the DeviceMaster you want to add.
2. Access the *New Device* window using one of these methods:
  - Click **Add New > Device** in the *Manage* menu.
  - Right-click a folder or a RocketLinux switch in the *Device Tree* pane (anywhere in the pane, as long as a DeviceMaster is not highlighted and you are in a valid folder) and click **Add New > Device**.
3. Select the DeviceMaster in the **Device Type** drop list.

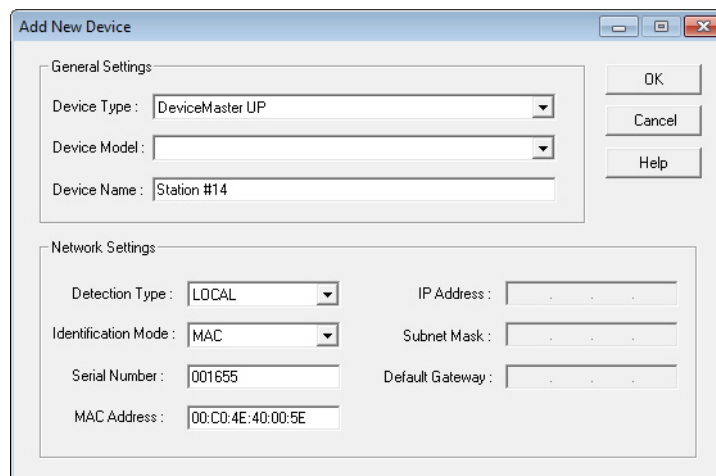

4. Select the appropriate model in the **Device Model** drop list.
5. Enter a friendly device name in the **Device Name** list box.
6. Select **LOCAL** for the *Detection Type*.

7. Enter the MAC address or network information.  
**Note:** A MAC address label is attached to all DeviceMaster units. The first three pairs of digits start with 00 C0 4E.
8. Optionally, enter the serial number in the **Serial Number** list box.
9. Click **Ok**.
10. If necessary, click **Refresh** for the new DeviceMaster to display in the *Device Tree* or *Device List* panes. The DeviceMaster shows OFF-LINE if it is not attached to the network or if an incorrect IP address was entered.

## Changing the Bootloader Timeout

1. Use the following procedure to change the Bootloader timeout to 45 seconds. You can use this procedure to return the Bootloader timeout to 15 seconds after you have successfully uploaded the firmware. If necessary, use your browser to access the DeviceMaster using the IP address.
2. Click **Network**.
3. Enter 45 in the **Boot Timeout** field and click **Save**.

The screenshot shows the 'Network Configuration' page of the DeviceMaster. The navigation bar at the top includes 'Home', 'Serial', 'Ethernet', 'Network', 'Diagnostics', 'System', 'DeviceMaster 4-Port 2E', and 'Logout'. Below the navigation bar, there are tabs for 'Configuration', 'Password', 'Security', 'Keys/Certs', and 'EtherNet/IP'. The main content area is titled 'Network Configuration' and is divided into two sections: 'General' and 'IP Configuration (IPv4)'. In the 'General' section, the 'Boot Timeout' field is highlighted in yellow and contains the value '45'. In the 'IP Configuration (IPv4)' section, the 'Use static configuration below' radio button is selected, and the 'IP Address' field contains '10.0.0.54' and the 'Subnet Mask' field contains '255.255.0.0'. A 'Save' button is located at the bottom right of the configuration area and is highlighted with a red box. A note at the bottom of the IP configuration section states: 'NOTE: Changing these options will cause the gateway to reboot.' The footer of the page reads '© Copyright Control Corp.'

**Note:** You should return the Bootloader Timeout value back to 15 seconds after you upload the firmware.

## Using Configuration Files

This subsection discusses how to create (save) and load DeviceMaster configuration files. You may want to create DeviceMaster configuration files for these reasons:

- Save the DeviceMaster configuration settings so that you can load them on similar DeviceMasters to save configuration time
- Save the DeviceMaster configuration settings because you need to remove a firmware version to install a new firmware version and you want to reload the configuration settings into the new firmware.

### Saving Configuration Files

Use this procedure to save configuration files.

1. Enter the IP address into your browser to access the web interface.
2. Click **System | Configuration File**.
3. Click the **Save Configuration** button.

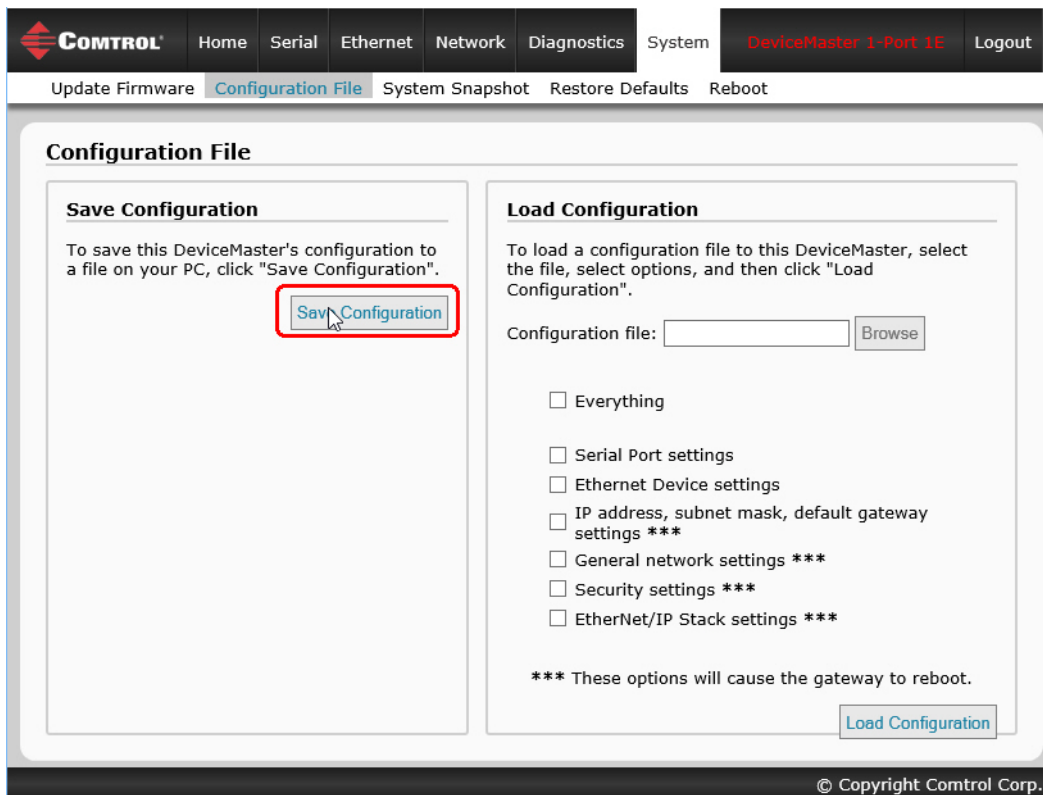

4. Depending on your browser, may need to click save or direct it to a specific file location.



## Loading Configuration Files

Use the following procedure to load configuration files.

1. If necessary, enter the IP address in your browser.
2. Click **System | Configuration File**.
3. Click the **Browse** button and select the configuration file. The default configuration file name is:

`dm_XXX.XXX.XXX.XXX.ds`

Where `xxx.xxx.xxx.xxx` is the IP address and `.ds` is the file extension.

4. Select the categories that you want to load and then click the **Load Configuration** button.

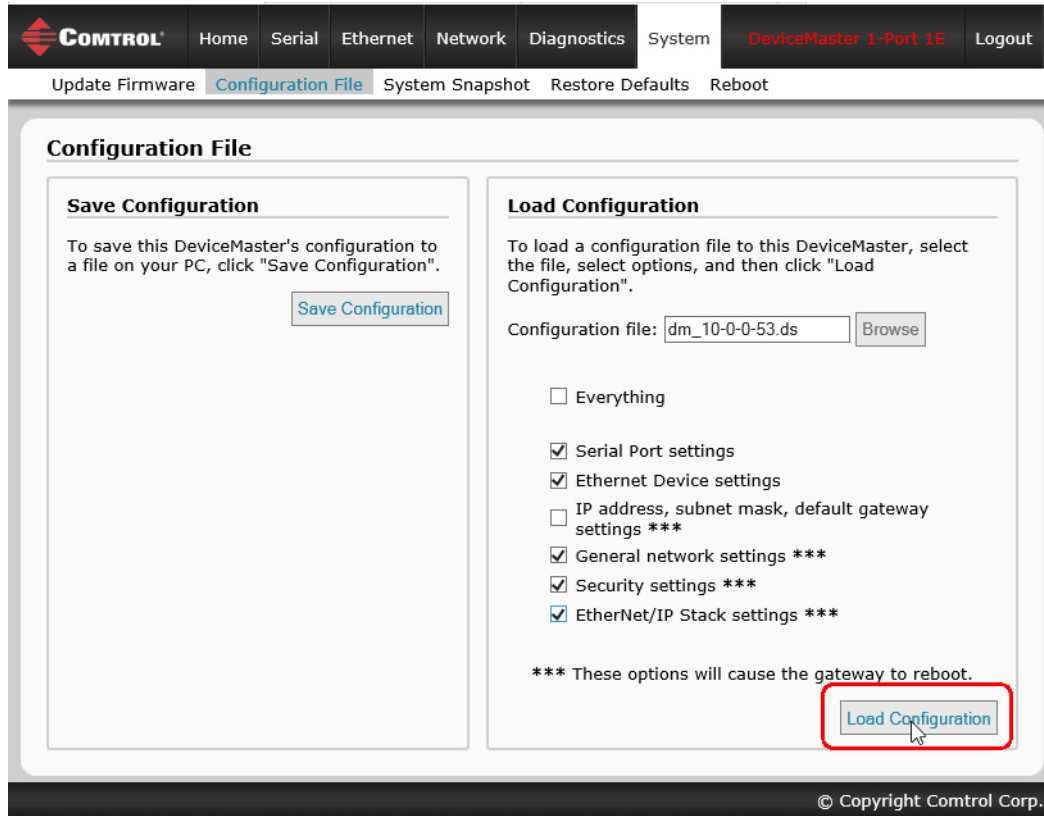

The DeviceMaster reboots and you are redirected to the web page.

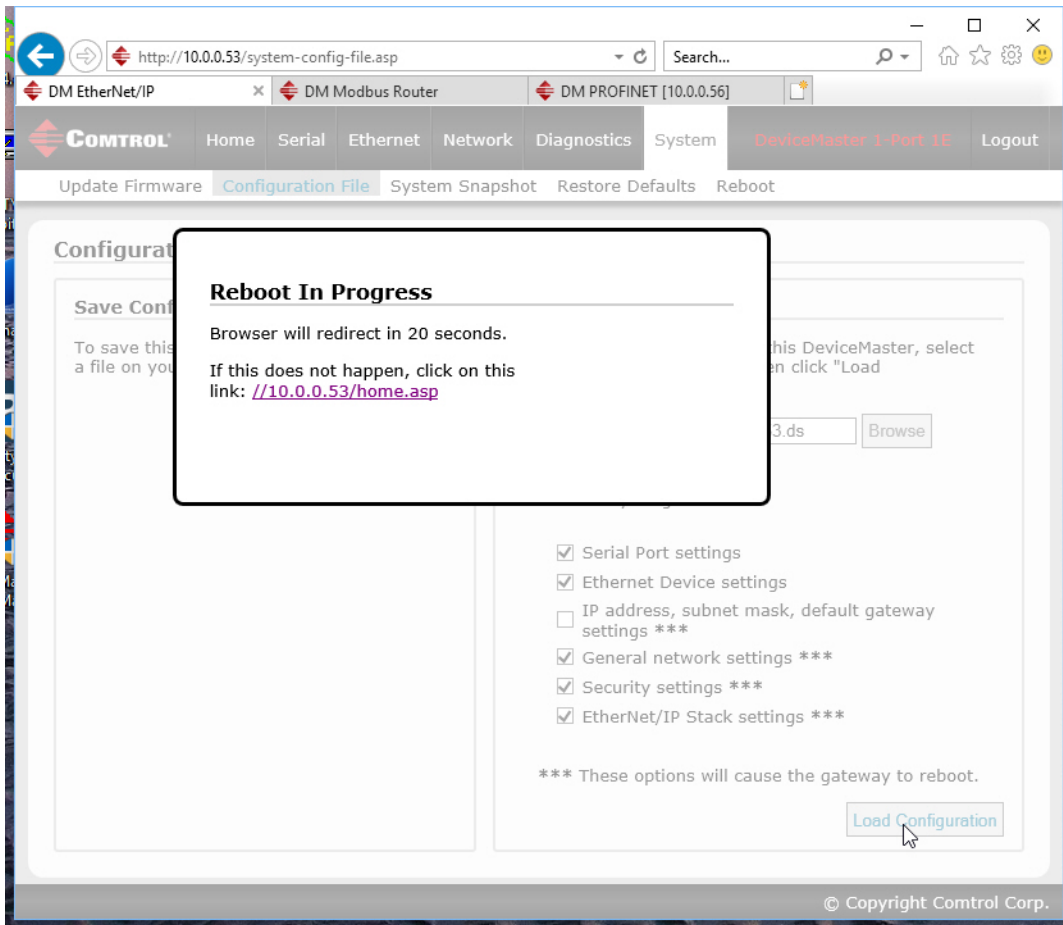

## Managing Bootloader

---

*Bootloader* refers to the operating system that runs on the DeviceMaster hardware during the power on phase, which then loads the default application (for example, EtherNet/IP firmware).

**Note:** Typically, you should not update the Bootloader unless advised to do so by Control Technical Support.

There are several methods and tools that you can use to check the Bootloader version or update the Bootloader.

- **PortVision DX** is the easiest way to check the Bootloader version and upload the latest version.
- Optionally, RedBoot can be used to check the Bootloader version and update the Bootloader. See [RedBoot Procedures](#) on Page 65 for procedures.

### Checking the Bootloader Version

---

The following procedure uses PortVision DX to check the Bootloader version. Optionally, you can use RedBoot, see [Determining the Bootloader Version](#) on Page 69.

1. If you have not done so, install PortVision DX ([Installing PortVision DX](#) on Page 22) and **Scan** the network.
2. Right-click the DeviceMaster in the *Device List* pane and click **Advanced > Reboot**.
3. Click **Yes** to the *Confirm Reboot* query.
4. Right-click the DeviceMaster in the *Device List* pane, click **Refresh**. You may need to do this several times until you catch the reboot cycle in the *Device List* pane. The Bootloader version is briefly displayed during the reboot cycle before the application (for example, EtherNet/IP firmware) loads.
5. Check the Control web site to see if a [later version](#) is available.
6. Go to the next subsection if you need upload a new version of Bootloader.

### Uploading Bootloader

---

Use the following procedure to upload Bootloader to the DeviceMaster. Typically, you should not update the Bootloader unless advised to do so by Control Technical Support or a notice has been posted to the firmware download page on the ftp site.

**Note:** Technical Support does not recommend updating Bootloader across a WAN. For best results, connect the DeviceMaster directly to a PC or laptop to upload Bootloader.



**Make sure that power is not interrupted while uploading Bootloader. Power interruption while uploading Bootloader will require that the DeviceMaster must be sent into Control so that it can be reflashed.**

**If you are not successful uploading firmware into the DeviceMaster, do not upload Bootloader.**

1. If you have not done so, install PortVision DX ([Installing PortVision DX](#) on Page 22) and **Scan** the network.
2. If necessary, check the Bootloader version ([Checking the Bootloader Version](#)) and download the latest version.

- Right-click the DeviceMaster for which you want to update, click **Advanced > Upload Firmware**, browse to the Bootloader .cmtl file, and then click **Open**.

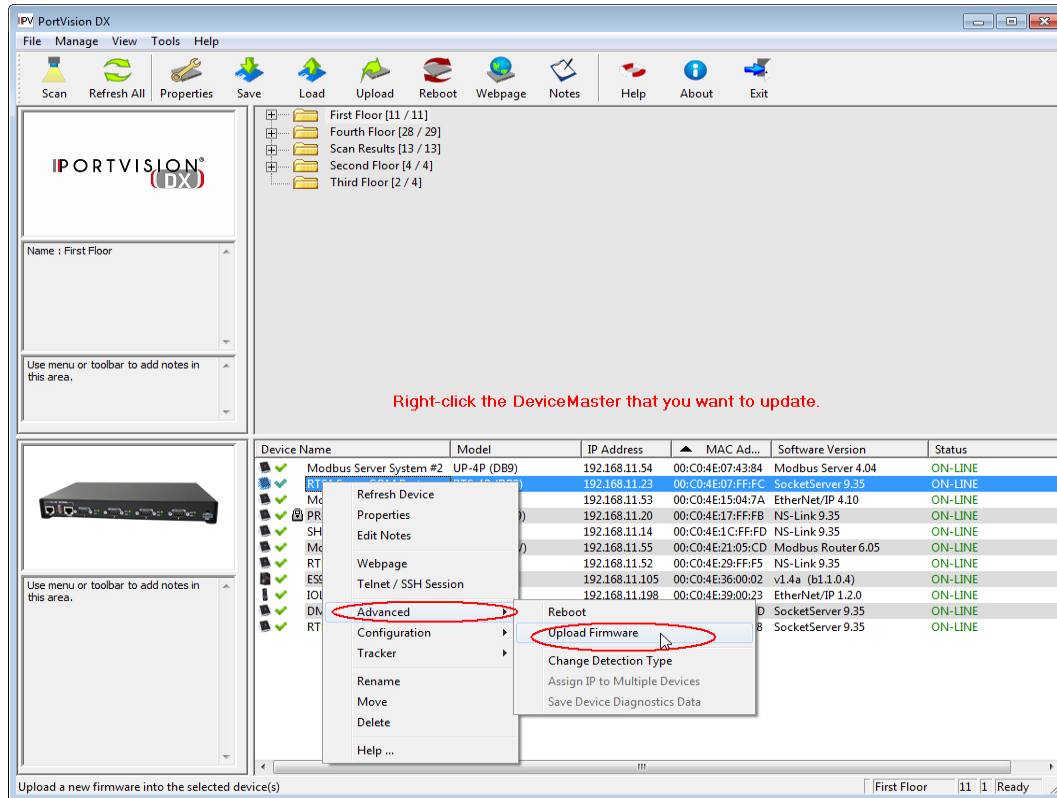

- Click **Yes** to the *Upload Firmware* message that warns you that this is a sensitive process.

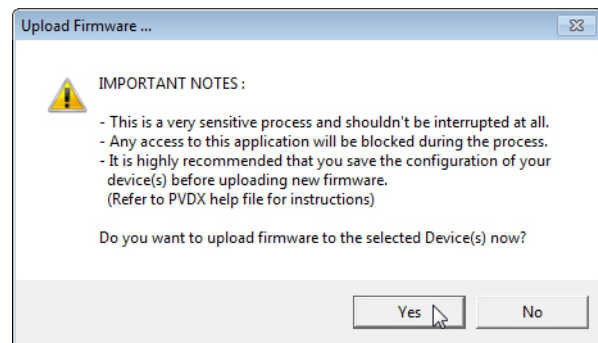

- Click **Ok** to the second *Upload Firmware* message.
- Right-click the DeviceMaster and click **Refresh** until the Bootloader version displays in the *Device List* pane and verify that the new version loaded.

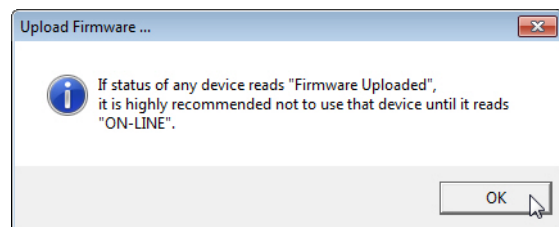

## Restoring Factory Defaults (Specific Models - Reset Button)

Use the following procedures to restore the DeviceMaster DIN rail models to the factory defaults.

To return to default port settings, see [Restoring Defaults](#) on Page 61.

If Technical Support advises you to restore the DeviceMaster factory defaults, depress the **Reset/Restore** switch for greater than 5 seconds.

Restoring the DeviceMaster DIN rail models resets the following to their factory defaults:

- Port settings
- Network settings
- Password
- Telnet enable
- Start up time-out
- SSL enable
- Telnet time-out

## Restoring Defaults

Use the following procedure to return some or all of the DeviceMaster settings to factory default values.

1. Open the web interface by entering the IP address in your browser.
2. Click **System | Restore Defaults**.
3. Select the items that you want to restore to factory defaults.
4. Click the **Restore** button.

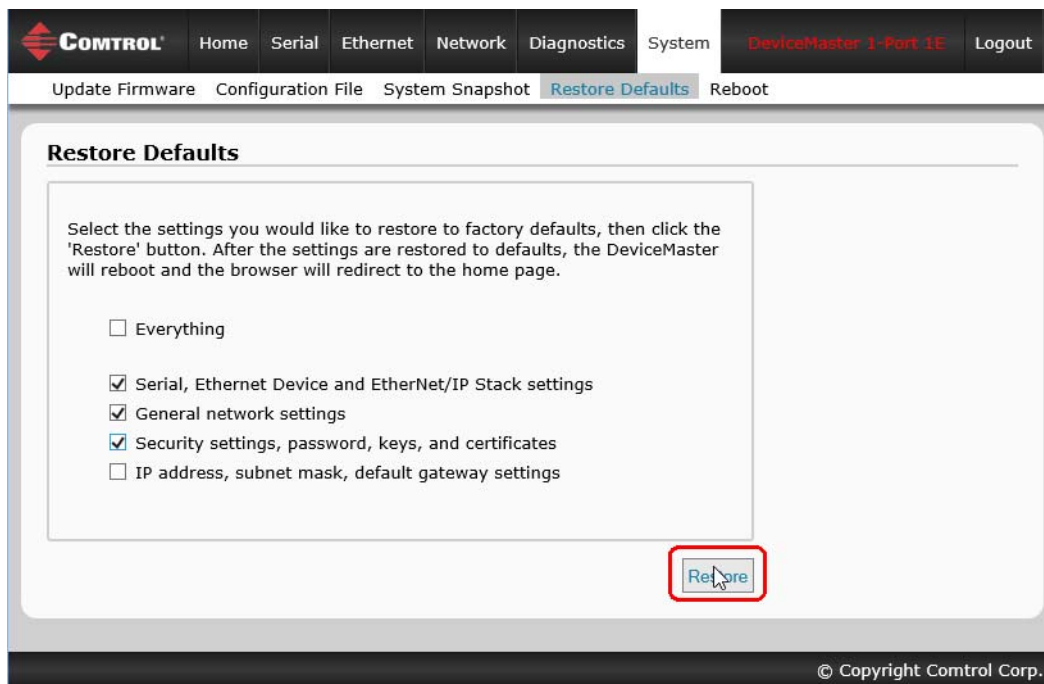

## Accessing RedBoot Commands in Telnet/SSH Sessions (PortVision DX)

You can open a Telnet or SSH session using PortVision DX to access RedBoot commands.

Use the following procedure to access a telnet or SSH session with PortVision DX.

1. In PortVision DX, right-click the DeviceMaster in the *Device List* pane for which you want to open a telnet session, and click **Telnet/SSH Session**.

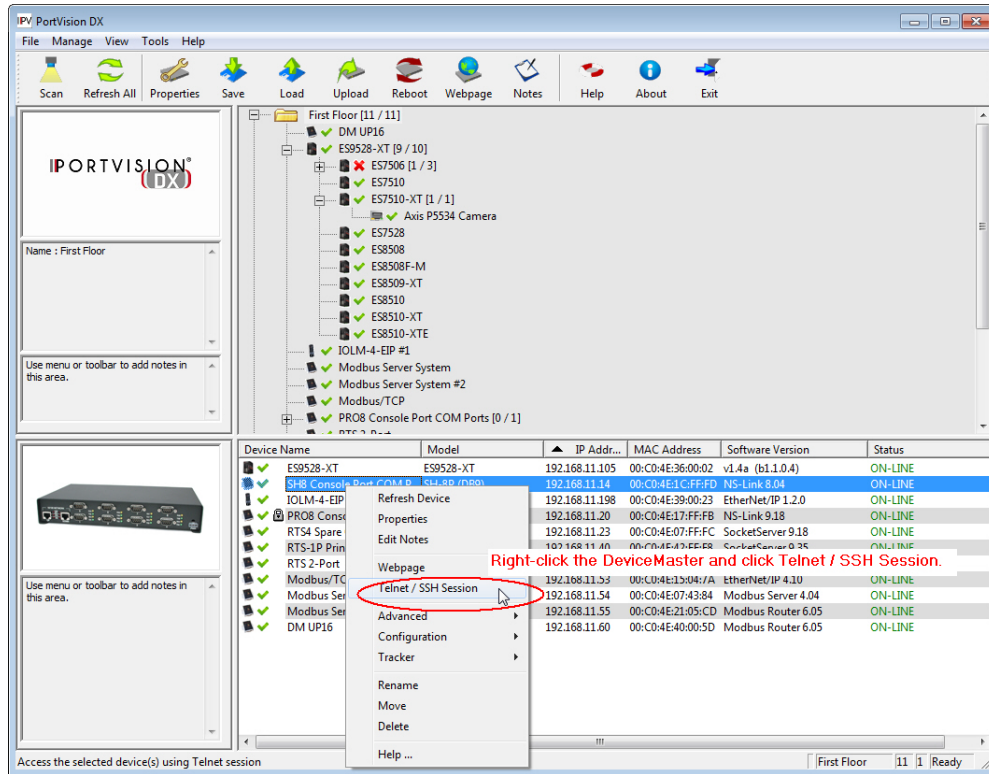

2. Select **Telnet** or **SSH**, leave the **Selected Port** number, and click **Ok**.

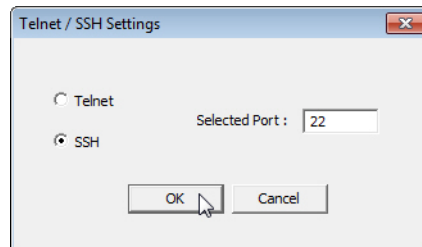
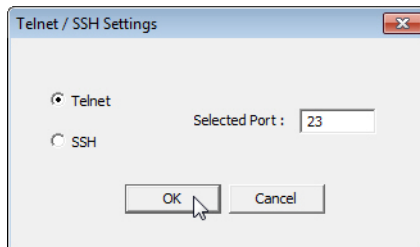

3. If necessary, enter the password and press **Enter**. If a password has not been set, press **Enter**. If using an SSH session, press **Enter** to the **login** as prompt.

If the PuTTY screen flashes in the background and does not appear as shown above, make sure that **Enable Telnet/ssh** has not been disabled in the web page. To check this, return to PortVision DX, right-click the

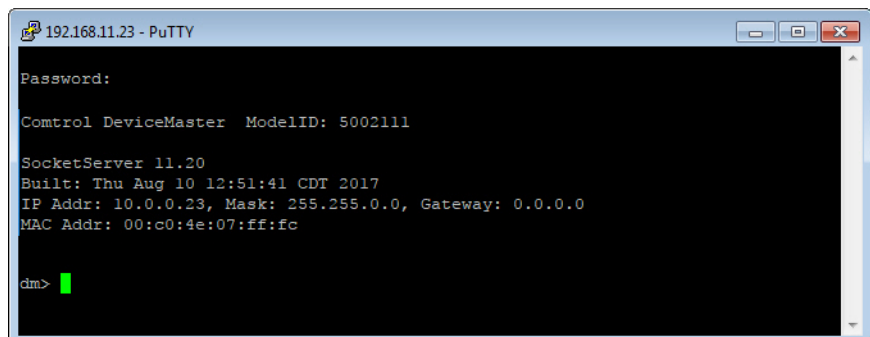

DeviceMaster in the *Device List* pane, and click **Webpage**. Click the **Network | Security** and verify that the **Enable Telnet/ssh** option is enabled, If it is not, click the option and then click **Save**, and close the web interface.

4. Type **Reset**, press **Enter**, and close the telnet session.

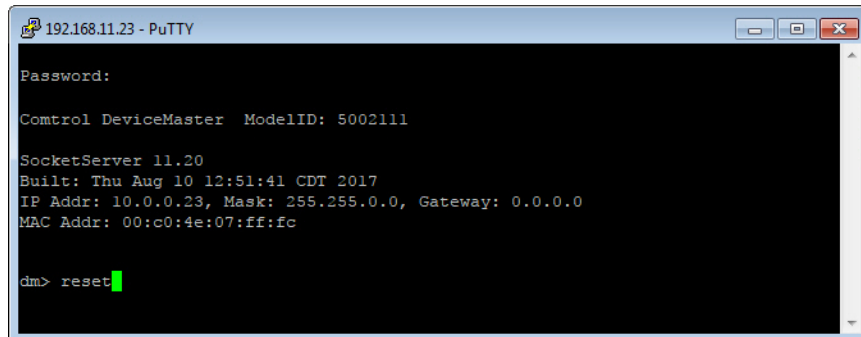

5. Quickly re-open the telnet or SSH session using the previous steps.

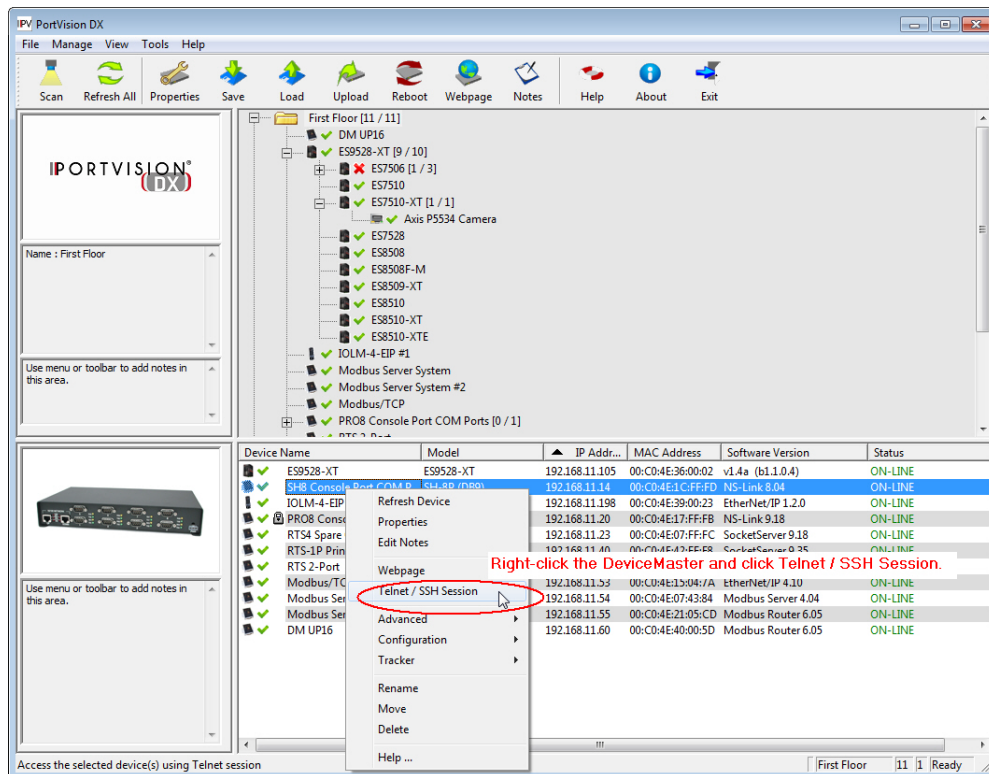

6. Select **Telnet** or **SSH**, leave the **Selected Port** number, and click **Ok**.

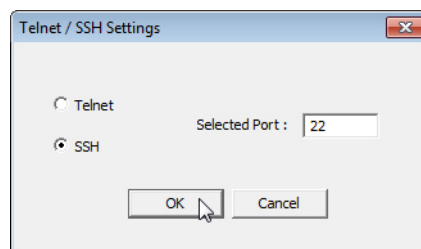
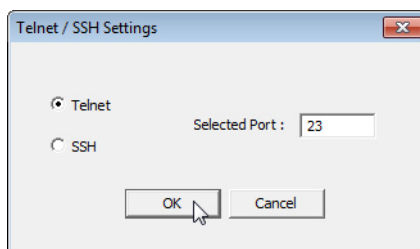



7. Press **Enter**. You can type **help** to review the RedBoot commands. You can also refer to [RedBoot Command Overview](#) on Page 71.

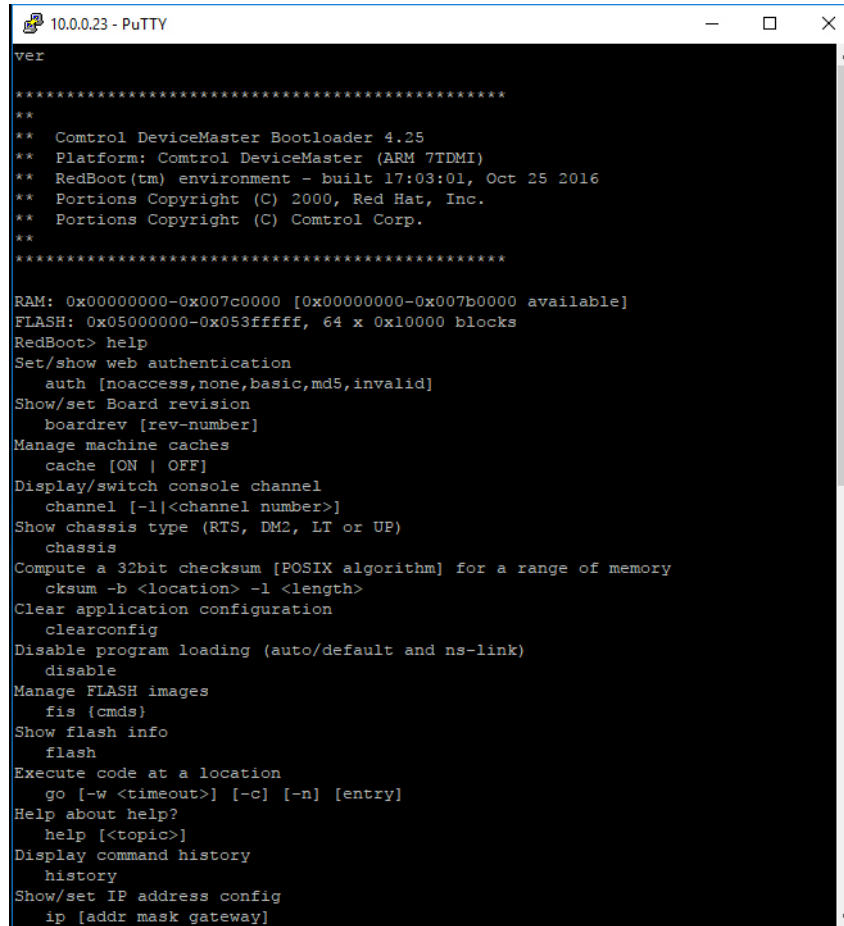

```
10.0.0.23 - PuTTY
ver
*****
**
**  Control DeviceMaster Bootloader 4.25
**  Platform: Control DeviceMaster (ARM 7TDMI)
**  RedBoot(tm) environment - built 17:03:01, Oct 25 2016
**  Portions Copyright (C) 2000, Red Hat, Inc.
**  Portions Copyright (C) Control Corp.
**
*****

RAM: 0x00000000-0x007c0000 [0x00000000-0x007b0000 available]
FLASH: 0x05000000-0x053fffff, 64 x 0x10000 blocks
RedBoot> help
Set/show web authentication
  auth [noaccess,none,basic,md5,invalid]
Show/set Board revision
  boardrev [rev-number]
Manage machine caches
  cache [ON | OFF]
Display/switch console channel
  channel [-l]<channel number>
Show chassis type (RTS, DM2, LT or UP)
  chassis
Compute a 32bit checksum [POSIX algorithm] for a range of memory
  cksum -b <location> -l <length>
Clear application configuration
  clearconfig
Disable program loading (auto/default and ns-link)
  disable
Manage FLASH images
  fis {cmds}
Show flash info
  flash
Execute code at a location
  go [-w <timeout>] [-c] [-n] [entry]
Help about help?
  help [<topic>]
Display command history
  history
Show/set IP address config
  ip [addr mask gateway]
```

**Note:** The *dm* prompt should be replaced by a *redboot* prompt. If not, you can reset the Bootloader timeout for a longer time period and retry this procedure.



# RedBoot Procedures

You can use this section as a reference if you want to perform tasks in RedBoot.

- [Accessing RedBoot Overview](#) on Page 65
- [Establishing a Serial Connection](#) on Page 66
- [Establishing a Telnet Connection](#) on Page 67
- [Determining the Network Settings](#) on Page 68
- [Configuring the Network Settings](#) on Page 68
- [Changing the Bootloader Timeout](#), Page 69
- [Determining the Bootloader Version](#) on Page 69
- [Resetting the DeviceMaster](#) on Page 70
- [Configuring Passwords](#) on Page 70
- [RedBoot Command Overview](#) on Page 71.

Optionally, you can install PortVision DX on a Windows system on the network and perform all of these tasks. PortVision DX provides a Telnet/SSH session, which is discussed in [Accessing RedBoot Commands in Telnet/SSH Sessions \(PortVision DX\)](#) on Page 62.

## Accessing RedBoot Overview

---

---

To access RedBoot, you can use one of the following methods:

- A *serial* connection between Port 1 on the DeviceMaster and a COM port on a PC (Page 66). If you plan on using the serial method, you will need a null modem cable, a terminal program installed and configured on the PC, and a **Bootloader Timeout** value in excess of 15 seconds. If the **Bootloader Timeout** value has been reduced to 1 second, this procedure will NOT be possible.

**Note:** Use the serial connection method, if the DeviceMaster is not on the same Ethernet network segment as the PC.

If you do not know the IP address of the DeviceMaster you must use a serial connection to communicate with the DeviceMaster.

- A *telnet* connection (Page 67), if the DeviceMaster is locally accessible by Ethernet. A *telnet connection* requires that you know the IP address. In addition, the IP address must also be valid for the network to which it is attached.

For example: The network segment must be 192.168.250.x to telnet to the DeviceMaster default IP address if you have not changed the IP address to operate on your network.

## Establishing a Serial Connection

---

---

Use the following procedure to set up a serial connection with a terminal server program. You can use HyperTerminal (Windows) or optionally, Test Terminal (WCom2), which can be accessed from PortVision DX using **Tools > Applications > Test Terminal (WCom2)**.

1. Connect a null-modem cable from an available COM port on your PC to **Port 1** on the DeviceMaster.

**Note:** See [Connecting Serial Devices](#) on Page 35, if you need to build a null-modem cable.

2. Configure the terminal server program to the following values:

- Bits per second = 57600
- Data bits = 8
- Parity = None
- Stop bits = 1
- Flow control = None

**Note:** If you do not disable Bootloader from loading (Steps 3 through 5) within the time-out period (default is fifteen seconds), an application will be loaded from flash and started. If this happens, repeat Steps 3 through 5. The **#!DM** command is the only case-sensitive command and must be in uppercase.

3. Reset the DeviceMaster.

**Note:** Depending on the model, disconnect and reconnect the power cable (external power supply and no power switch) or turn the power switch on and then off (internal power supply).

4. Immediately type **#!DM** and press **Enter** in the terminal program.

```
#!DM
RedBoot>dis
Loading disabled
```

5. At the **RedBoot>** prompt, type **dis**, and press **Enter**.
6. Verify that loading has been disabled.
7. You can use the appropriate procedure listed on Page 65 or use the [RedBoot Command Overview](#) on Page 71 to perform the desired task.

## Establishing a Telnet Connection

Use the following procedure to telnet to the DeviceMaster.

1. Open a telnet session, enter the DeviceMaster IP address.

If using Windows, you can use PortVision DX, see [Accessing RedBoot Commands in Telnet/SSH Sessions \(PortVision DX\)](#) on Page 62.

2. Press the **Enter** key if you did not program a password or type the password and press **Enter**.

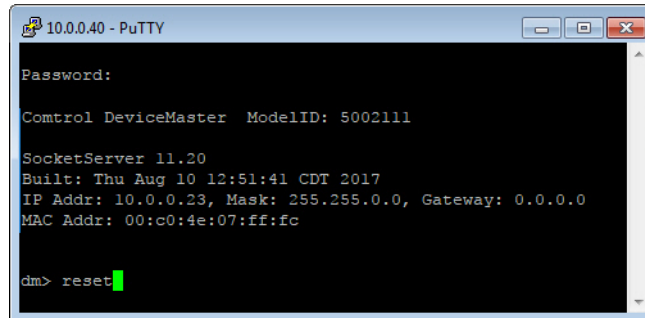

```
10.0.0.40 - PuTTY
Password:
Control DeviceMaster ModelID: 5002111
SocketServer 11.20
Built: Thu Aug 10 12:51:41 CDT 2017
IP Addr: 10.0.0.23, Mask: 255.255.0.0, Gateway: 0.0.0.0
MAC Addr: 00:c0:4e:07:ff:fc
dm> reset
```

**Note:** The DeviceMaster does not come pre-programmed with a password.

3. Type **reset**, and close the session.
4. Open a new telnet session, enter the DeviceMaster IP address, and the password.
5. Type **dis** to disable the Bootloader.
6. Verify that the system responds with a **Loading disabled** message.

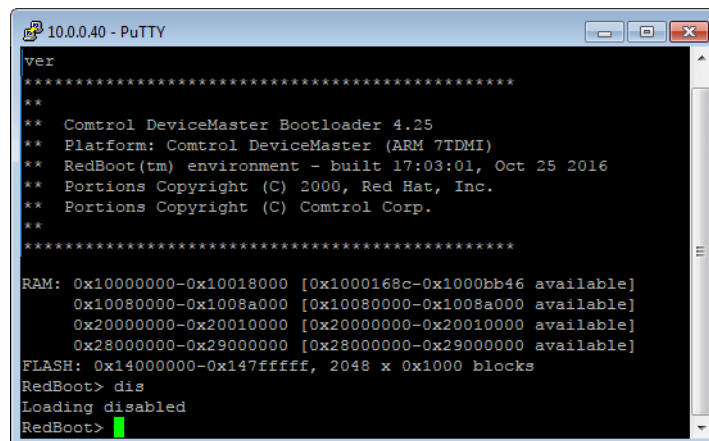

```
10.0.0.40 - PuTTY
ver
*****
**
** Control DeviceMaster Bootloader 4.25
** Platform: Control DeviceMaster (ARM 7TDMI)
** RedBoot(tm) environment - built 17:03:01, Oct 25 2016
** Portions Copyright (C) 2000, Red Hat, Inc.
** Portions Copyright (C) Control Corp.
**
*****
RAM: 0x10000000-0x10018000 [0x1000168c-0x1000bb46 available]
      0x10080000-0x1008a000 [0x10080000-0x1008a000 available]
      0x20000000-0x20010000 [0x20000000-0x20010000 available]
      0x28000000-0x29000000 [0x28000000-0x29000000 available]
FLASH: 0x14000000-0x147fffff, 2048 x 0x1000 blocks
RedBoot> dis
Loading disabled
RedBoot>
```

## Determining the Network Settings

---

---

If you are not sure what the network information is on a DeviceMaster, you can perform the following procedure.

The default network settings are:

- IP address: 192.168.250.250
  - Subnet mask: 255.255.0.0
  - Gateway address: 192.168.250.1
1. Establish communications with the DeviceMaster using the serial (Page 66) or telnet (Page 67) method.
  2. At the **RedBoot** prompt, type **ip**.

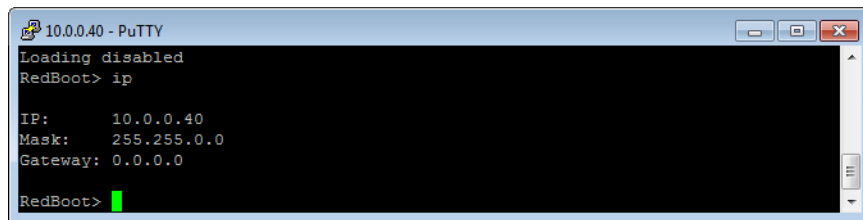

The IP address, subnet mask, and IP gateway values will display.

**Note:** *Optionally, you can install PortVision DX on a Windows system on the network and see the IP information in the Device List pane.*

## Configuring the Network Settings

---

---

Use the following procedure to program the IP address using RedBoot.

1. Establish communications with the DeviceMaster using the serial (Page 66) or telnet (Page 67) method.
2. Enter **ip [addr mask gateway]** and press the **Enter** key to configure the IP address. *Where:*
  - addr** = IP address you want to use
  - mask** = matches you network subnet mask
  - gateway** = assigned by your network administrator

*Make sure that each value is separated by a space.*

```
RedBoot>dis
Loading disabled
RedBoot> ip 192.168.11.152 255.255.0.0 192.168.0.254
RedBoot>
IP:      192.168.11.152
Mask:    255.255.0.0
Gateway: 192.168.0.254
RedBoot> reset
.. Resetting
```

3. Verify that RedBoot responds with your configured network information or reissue the command.
4. Type **reset** to reset the DeviceMaster, if you do not have any other related RedBoot tasks.

## Changing the Bootloader Timeout

Use the following procedure to change the Bootloader timeout value.

1. Establish communications with the DeviceMaster using the serial (Page 66) or telnet (Page 67) method.
2. At the **RedBoot** prompt, type **timeout**.

```
RedBoot> dis
Loading disabled
RedBoot> timeout
Timeout 15 seconds
RedBoot> timeout 45
timeout 45 seconds
RedBoot>_
```

RedBoot responds with the current Bootloader timeout value.

3. Type **timeout** and a value to change the timeout value. For example, **timeout 45** to change the Bootloader timeout to 45 seconds.

## Determining the Bootloader Version

Use the following procedure to determine what Bootloader version is loaded in the DeviceMaster.

1. Establish communications with the DeviceMaster using the serial (Page 66) or telnet (Page 67) method.
2. At the **RedBoot** prompt, type **version**.

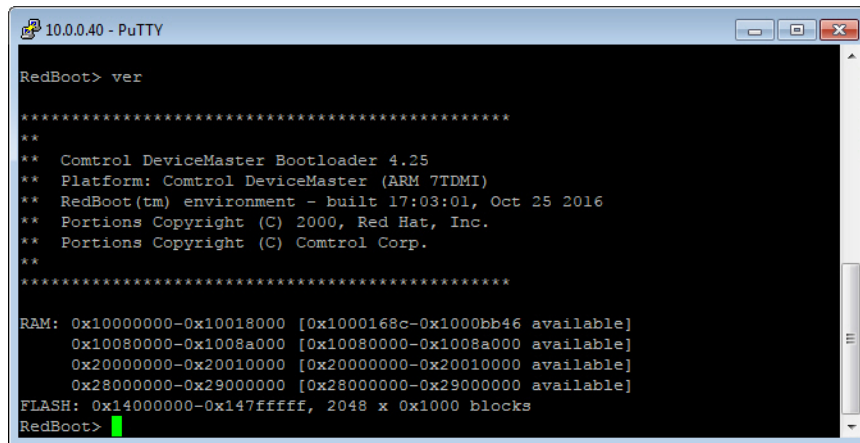

```
10.0.0.40 - PuTTY
RedBoot> ver
*****
**
** Control DeviceMaster Bootloader 4.25
** Platform: Control DeviceMaster (ARM 7TDMI)
** RedBoot(tm) environment - built 17:03:01, Oct 25 2016
** Portions Copyright (C) 2000, Red Hat, Inc.
** Portions Copyright (C) Control Corp.
**
*****
RAM: 0x10000000-0x10018000 [0x1000168c-0x1000bb46 available]
      0x10080000-0x1008a000 [0x10080000-0x1008a000 available]
      0x20000000-0x20010000 [0x20000000-0x20010000 available]
      0x28000000-0x29000000 [0x28000000-0x29000000 available]
FLASH: 0x14000000-0x147fffff, 2048 x 0x1000 blocks
RedBoot>
```

The Bootloader information displays.

3. Type **reset** to reset the DeviceMaster, if you do not have any other related RedBoot tasks.

**Note:** *Optionally, you can install PortVision DX on a Windows system on the network and see the Bootloader version in the Device List pane. Reboot the DeviceMaster, right-click the DeviceMaster and click Refresh Device until the Bootloader version displays. The Bootloader version is only displayed for a few moments.*

---

## Resetting the DeviceMaster

---

When you have completed your tasks in RedBoot, you must enter a **reset** command at the **RedBoot>** prompt for the DeviceMaster to begin operation.

**Note:** The [LEDs](#) on the DeviceMaster will go through the power up sequence. The DeviceMaster has completed its reset cycle when the **Status LED** is lit and it stops flashing.

```
RedBoot> dis
Loading disabled
RedBoot> reset
```

---

## Configuring Passwords

---

This section discusses how to configure a password for the web and telnet server.

Use the following procedure to establish the DeviceMaster password for the Web and telnet server. Establishing a password prevents unauthorized changes to the DeviceMaster configuration.

1. Establish communications with the DeviceMaster using the serial (Page 66) or telnet method (Page 67).
2. Type **password [your\_password]** and press **Enter**.

**Note:** If you forget your password, you can reprogram the password using the serial method which bypasses the password.

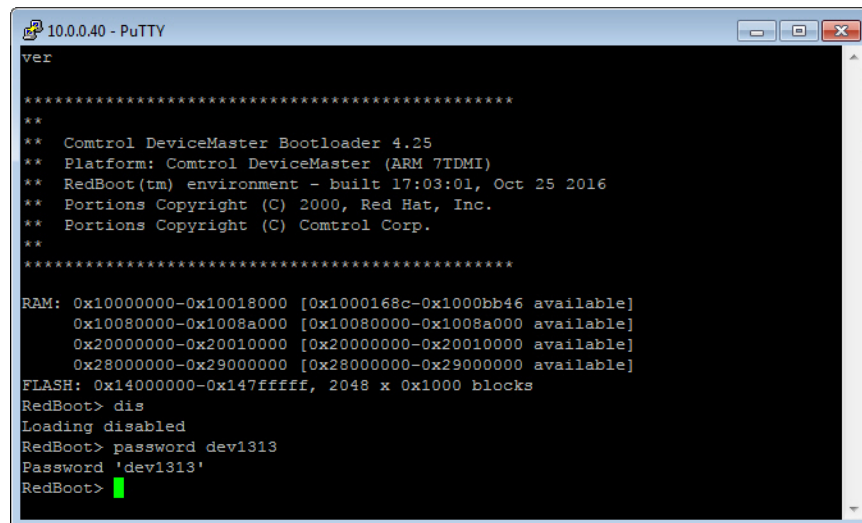

```
10.0.0.40 - PuTTY
ver
*****
**
** Control DeviceMaster Bootloader 4.25
** Platform: Control DeviceMaster (ARM 7TDMI)
** RedBoot(tm) environment - built 17:03:01, Oct 25 2016
** Portions Copyright (C) 2000, Red Hat, Inc.
** Portions Copyright (C) Control Corp.
**
*****

RAM: 0x10000000-0x10018000 [0x1000168c-0x1000bb46 available]
      0x10080000-0x1008a000 [0x10080000-0x1008a000 available]
      0x20000000-0x20010000 [0x20000000-0x20010000 available]
      0x28000000-0x29000000 [0x28000000-0x29000000 available]
FLASH: 0x14000000-0x147fffff, 2048 x 0x1000 blocks
RedBoot> dis
Loading disabled
RedBoot> password dev1313
Password 'dev1313'
RedBoot>
```

**Note:** The Bootloader version on your DeviceMaster may be different than the version displayed in this graphic.

See the **auth** command in the [RedBoot Command Overview](#) on Page 71, if you want to set up Web browser authentication.

## RedBoot Command Overview

The following table is an overview of RedBoot commands available. After accessing RedBoot, you can review the list of commands online by entering **help** and pressing the **Enter** key.

For more detailed information, see the *eCos Reference Manual* that you can download from: [http://downloads.comtrol.com/dev\\_mstr/UP/software/redboot/user\\_guide](http://downloads.comtrol.com/dev_mstr/UP/software/redboot/user_guide).

RedBoot Commands	
<b>auth</b> {noaccess, none, basic, md5, invalid}	Sets or displays web authentication. The default is set to <b>none</b> , which means that there is no authentication required to access the web server.  To deny access to the web server, click <b>noaccess</b> or <b>invalid</b> . If access is attempted, a message appears to notify the user that access is denied.  To configure the web server to request an un-encrypted password, click <b>basic</b> . To configure the web server to request an encrypted password, click <b>md5</b> . (Some browsers do not support the <b>md5</b> command.)
<b>boardrev</b> †	Displays the board revision.
<b>cache</b> [ON   OFF]	Manages machine caches.
<b>channel</b> [-1 <channel number>]	Displays or switches the console channel.
<b>chassis</b>	Displays chassis information.
<b>cksum -b &lt;location&gt; -l &lt;length&gt;</b>	Computes a 32-bit checksum [POSIX algorithm] for a range of memory.
<b>clearconfig</b>	Clears the application configuration.
<b>disable</b>	Disables automatic load of the default application.
<b>fis</b> {cmds}	Manages flash images. See Chapter 2 of the <a href="#">eCos Reference Manual</a> for {cmds} information.
<b>flash</b>	Shows flash information.
<b>go</b> [-w <timeout>] [-c] [-n] [entry]	Executes code at a location.
<b>help</b> <topic>	Displays available RedBoot commands.
<b>history</b>	Displays command history.
<b>ip</b> [addr mask gateway]	Displays or sets the IP address configuration.
<b>load</b> [-r] [-v] [-h <host>] [-p <TCP port>] [-m <varies>] [-c <channel_number>] [-b <base_address>] <file_name>	Loads a file from TFTP server or XModem.
<b>loop</b> 232 422 int port-number	Runs loopback test on port. The DeviceMaster Serial Hub does not support this command.
<b>mac</b> †	Displays Ethernet MAC address.
<b>model</b> †	Shows model number.
<b>password</b> {password}	Sets or deletes the password.
<b>ping</b> [-v] [-n <count>] [-l <length>] [-t <timeout>] [-r <rate>] [-i <IP_addr>] -h <IP_addr>	Network connectivity test.
<b>reset</b>	Resets the DeviceMaster.
<b>secureconf</b> [disable enable]	Sets or displays secure config enable.
<b>securedata</b> [disable enable]	Sets or displays secure data enable.

<b>RedBoot Commands (Continued)</b>	
<b>sernum</b> [prefix] [serial_number] <b>sernum</b> [serial_number]†	Displays device serial number (if available).
<b>?</b>	Displays short help.
<b>snmp</b> [disable enable]	Sets or displays SNMP enable.
<b>summary</b>	Displays a summary that includes the bootloader version, network address information, MAC address, and security settings.
<b>telnet</b> [disable   enable]	Sets or displays telnet server enable. Disables telnet.
<b>teltimeout</b> [seconds]	Shows or sets telnet time-out.
<b>terse</b>	Terse command response mode.
<b>t485 port #1 port #2</b>	Runs port-to-port RS-485 test. This is not available on the DeviceMaster Serial Hub. Port numbering is Port 0 through 15 and you must connect a straight-through cable such as Ethernet patch cord.
<b>timeout</b> {seconds}	Displays or sets Bootloader time-out value.
<b>version</b>	Displays RedBoot version information.
† <i>Read-only items that you cannot change in Redboot.</i>	



# External Power Supply Specifications

This section discusses information that you may need if you wish to use your own external power supplies.

- [1-Port Panel Mount 5-30VDC Power Supply](#) on Page 73
- [EIP-2101 and EIP-2201: 1-Port DIN Rail Power Supply](#) on Page 74
- [EIP-2202 and EIP-2402: 2-Port \(Serial Terminals\) Power Supply](#) on Page 75
- [EIP-2102 and EIP-2302: 2-Port DB9 Power Supply \(Bottom\)](#) on Page 76
- [EIP-2102 and EIP-2302: 2-Port DB9 Power Supply \(Top\)](#) on Page 77
- [EIP-2304: 4-Port DIN Rail Models Power Supply](#) on Page 78
- [4-Port Panel Mount Power Supply](#) on Page 78

## 1-Port Panel Mount 5-30VDC Power Supply

This table provides specifications for the power supply shipped with the DeviceMaster 1-port panel mount.

Control Power Supply: 1-Port 5-30VDC	
Input line frequency	43-63 Hz
Input line voltage	90-260 VAC
Output voltage	24VDC
Output current	500 mA @ 24VDC

This table provides the specifications, if you intend on using your own power supply.

Control device 1-Port 5-30VDC External Power Supply	
Output voltage†	5-30VDC
Current†	100 mA (Min) @ 24VDC
Power	2.5 W
† Any power supply that meets current consumption, voltage, power, and connector pin outs requirements can be used.	

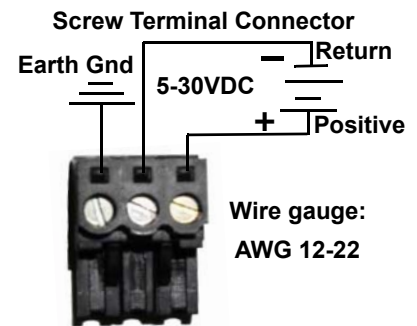

## EIP-2101 and EIP-2201: 1-Port DIN Rail Power Supply

This table provides the specifications to purchase a power supply for a DeviceMaster EIP-2101 and EIP-2201 1-port DIN rail.

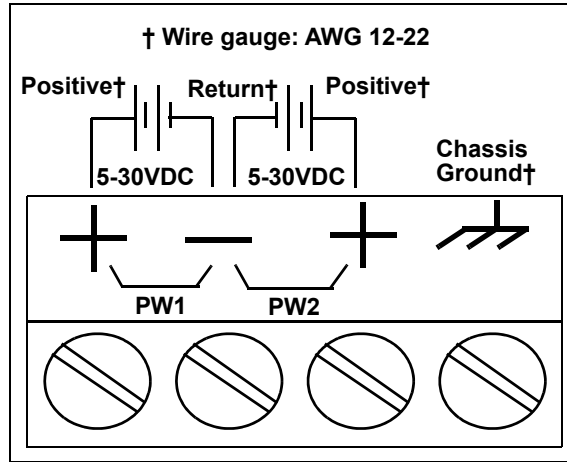

This table provides the specifications, if you intend on using your own power supply.

<b>DeviceMaster EIP-2101 and EIP-2201 1-Port DIN Rail External Power Supply</b>	
Output voltage†	5-30VDC
Current†	100 mA (Min) @ 24VDC
Power	2.5 W
† Any power supply that meets current consumption, voltage, power, and connector pin outs requirements can be used.	

## EIP-2202 and EIP-2402: 2-Port (Serial Terminals) Power Supply

This table provides the specifications to purchase a power supply for a DeviceMaster 2-port (EIP-2202 and EIP-2402) with serial terminals DIN rail.

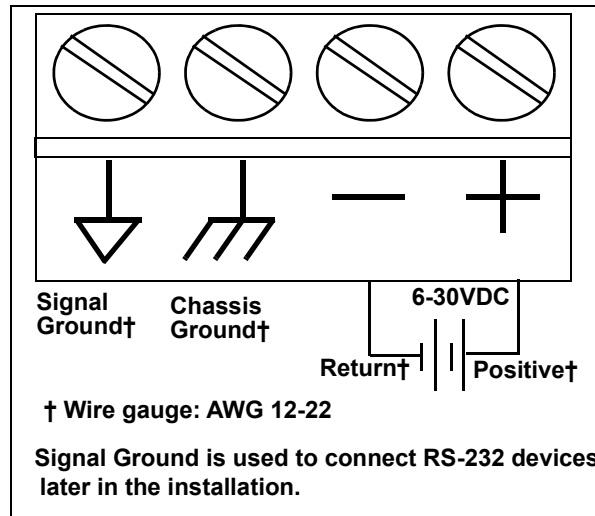

This table provides specifications if you intend on using your own power supply.

<b>Control device 2-Port DIN Rail (Serial Terminals) (EIP-2202 and EIP-2402) External Power Supply</b>	
Output voltage†	6-30VDC
Current†	100 mA (Min) @ 24VDC
Power	2.5 W
† Any power supply that meets current consumption, voltage, power, and connector pin outs requirements can be used.	

## EIP-2102 and EIP-2302: 2-Port DB9 Power Supply (Bottom)

This table provides the specifications to purchase a power supply for a DeviceMaster 2-port 1E/2E models (EIP-2102 and EIP-2302) with DB9 connectors.

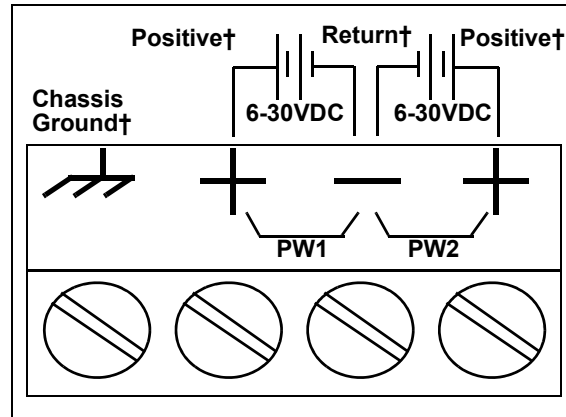

† Wire gauge: AWG 12-22

**Note:** The power supply for these model is on the bottom of the unit. The product serial numbers are before xxxx-030000, where xxxx is the first four digits of the serial number.

This table provides specifications if you intend on using your own power supply.

2-Port DB9 Models (Power Terminal - Bottom) External Power Supply	
Output voltage†	6-30VDC
Current†	100 mA (Min) @ 24VDC
Power	2.5 W
† Any power supply that meets current consumption, voltage, power, and connector pin outs requirements can be used.	

## EIP-2102 and EIP-2302: 2-Port DB9 Power Supply (Top)

This table provides the specifications to purchase a power supply for a DeviceMaster EIP-2102 and EIP-2302 2-port DB9 DIN rail.

**Note:** The power supply for this model is on the top of the unit. The product serial numbers are above xxxx-030000, where xxxx is the first four digits of the serial number.

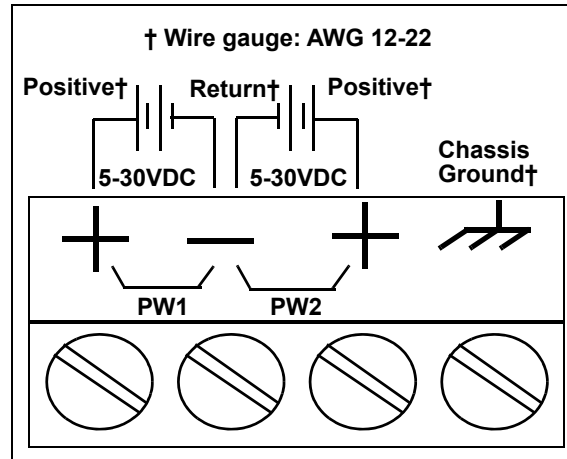

This table provides specifications if you intend on using your own power supply.

<b>EIP-2102 and EIP-2302: 2-Port DIN Rail External Power Supply</b>	
Output voltage†	5-30VDC
Current†	100 mA (Min) @ 24VDC
Power	2.5 W
† Any power supply that meets current consumption, voltage, power, and connector pin outs requirements can be used.	

## EIP-2304: 4-Port DIN Rail Models Power Supply

This table provides the specifications to purchase a power supply for a DeviceMaster EIP-2304 4-port (DIN rail).

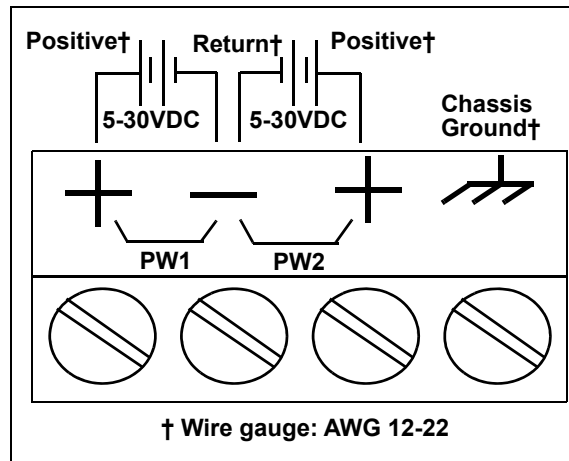

This table provides specifications if you intend on using your own power supply.

<b>EIP-2304: 4-Port DIN Rail External Power Supply</b>	
Output voltage†	5-30VDC
Current†	100 mA (Min) @ 24VDC
Power	2.5 W
† Any power supply that meets current consumption, voltage, power, and connector pin outs requirements can be used.	

## 4-Port Panel Mount Power Supply

This table provides the specifications for the power supply shipped with the DeviceMaster 4-port.

<b>Control Power Supply: 4-Port</b>	
Input line frequency	47 - 63 Hz
Input line voltage	90 - 260 VAC
Output voltage	24VDC
Output current	500 mA @ 24VDC

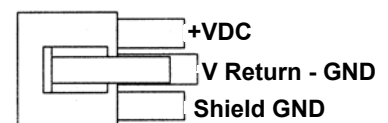

Housing Molex P/N:  
39-01-4030  
Pins Molex P/N:  
44485-1211

This table provides the specifications, if you intend on using your own power supply.

<b>External Power Supply: 4-Port</b>	
Output voltage†	9-30VDC
Current†	200 mA (Min) @ 24VDC
Power	4.8 W
† Any power supply that meets current consumption, voltage, power, and connector pin outs requirements can be used.	

# Troubleshooting and Technical Support

This section contains troubleshooting information for your DeviceMaster. You may want to review the following subsections before calling Technical Support because they will request that you perform many of the procedures or verifications before they will be able to help you diagnose a problem.

- [Troubleshooting Checklist](#) on Page 79
- [General Troubleshooting](#) on Page 81
- [Daisy-Chaining DeviceMaster 4-Port Units](#) on Page 82
- [DeviceMaster LEDs](#) on Page 83

If you cannot diagnose the problem, you can contact [Technical Support](#) on Page 84.

## Troubleshooting Checklist

---

---

The following checklist may help you diagnose your problem:

- Verify that you are using the correct types of cables on the correct connectors and that all cables are connected securely.

**Note:** Most customer problems reported to Control Technical Support are eventually traced to cabling or network problems.

Model	Connected to	Ethernet Cable	Connector Name
1-Port Panel	Ethernet hub or NIC	Standard	10/100 ETHERNET
EIP-2101 EIP-2201 1-Port (DIN Rail)	Ethernet hub or NIC	Standard	10/100
EIP-2102 EIP-2202 2-Port - 1E (Single Ethernet Port)	Ethernet hub or NIC	Standard	10/100
EIP-2302 EIP-2402 2-Port - 2E (Dual Ethernet Ports)	Ethernet hub or NIC	Standard	10/100 - E1/E2
EIP-2304 4-Port (DIN Rail)	Ethernet hub or NIC	Standard	10/100 - E1/E2
4-Port Panel	NIC	Standard	DOWN
	Ethernet hub	Standard	UP

- Verify that the network IP address, subnet mask, and gateway is correct and appropriate for the network. Make sure that the IP address programmed into the DeviceMaster matches the unique reserved IP configured address assigned by the system administrator.
  - If IP addressing is being used, the system should be able to ping the DeviceMaster.
  - If using DHCP, the host system needs to provide the subnet mask and gateway.
- Verify that the Ethernet hub and any other network devices between the system and the DeviceMaster are powered up and operating.
- Reboot the system, then reset the power on the DeviceMaster and watch the **PWR** or **Status** (Page 83) light activity.

<b>PWR or Status LED</b>	<b>Description</b>
5 sec. off, 3 flashes, 5 sec. off, 3 flashes...	RedBoot™ checksum failure.
5 sec. off, 4 flashes, 5 sec. off, 4 flashes...	SREC load failure.

- If you have a spare DeviceMaster, try replacing the device.



## General Troubleshooting

This table illustrates some general troubleshooting tips.

**Note:** Make sure that you have reviewed the [Troubleshooting Checklist](#) on Page 79.

General Condition	Explanation/Action
PWR or Status LED flashing	<p>Indicates that boot program has not downloaded to the unit.</p> <ol style="list-style-type: none"> <li>1. Reboot the system.</li> <li>2. Make sure that you have downloaded the most current firmware for your <a href="#">protocol</a>.</li> </ol> <p><b>Note:</b> If the PWR or Status LED is still flashing, contact Technical Support.</p>
PWR or Status LED flashing	<p>Indicates that boot program has not downloaded to the unit.</p> <ol style="list-style-type: none"> <li>1. Reboot the system.</li> <li>2. Make sure that you have downloaded the most current firmware for your <a href="#">protocol</a>.</li> </ol> <p><b>Note:</b> If the PWR or Status LED is still flashing, contact Technical Support.</p>
PWR or Status LED not lit	<p>Indicates that power has not been applied or there is a hardware failure. Contact Technical Support.</p>
Cannot ping the device through Ethernet hub	<p>Isolate the DeviceMaster from the network. Connect the device directly to the NIC in the host system.</p>
Cannot ping or connect to the DeviceMaster	<p>The default DeviceMaster IP address is often not accessible due to the subnet masking from another network unless <b>192.168</b> is used in the network.</p> <p>In most cases, it will be necessary to program in an address that conforms to your network.</p>
DeviceMaster continuously reboots when connected to some Ethernet switches or routers	<p>Invalid IP information may also cause the switch or router to check for a gateway address. Lack of a gateway address is a common cause.</p>

## Daisy-Chaining DeviceMaster 4-Port Units

---

---

The DeviceMaster 4-port (panel mount) models with external power supplies follow the IEEE specifications for standard Ethernet 10/100BASE-TX topologies.

**Note:** *If the serial number of your product is above xxxx-030000, the **UP** and **DOWN** Ethernet ports are interchangeable.*

When using the **UP** and **DOWN** ports, the DeviceMaster 4 is classified as a switch. When using the **UP** port only, it is a simple end node device.

The maximum number of daisy-chained DeviceMaster 4 units, and the maximum distance between units is based on the Ethernet standards and will be determined by your own environment and the conformity of your network to these standards.

Control has tested with seven DeviceMaster 4 units daisy-chained together using 10 foot CAT5 cables, but this is not the theoretical limit. You may experience a performance hit on the devices at the end of the chain, so it is recommended that you overload and test for performance in your environment. The OS and the application may also limit the total number of ports that may be installed.

Following are some quick guidelines and URLs of additional information. Note that standards and URLs do occasionally change.

- Ethernet 10BASE-T Rules
  - The maximum number of repeater hops is four.
  - You can use Category 3 or 5 twisted-pair 10BASE-T cables.
  - The maximum length of each cable is 100m (328ft).

**Note:** *Category 3 or 5 twisted pair cables look the same as telephone cables but they are not the same. The network will not work if telephone cables are used to connect the equipment.*
- Fast Ethernet 100BASE-TX rules
  - The maximum number of repeater hops is two (for a Class II hub). A Class II hub can be connected directly to one other Class II Fast Ethernet hub. A Class I hub cannot be connected directly to another Fast Ethernet hub.
  - You must use Category 5 twisted-pair 100BASE-TX cables.
  - The maximum length of each twisted-pair cable is 100m (328ft).
  - The total length of twisted-pair cabling (across directly connected hubs) must not exceed 205m (672ft).

**Note:** *Category 5 twisted pair cables look the same as telephone cables but they are not the same. The network will not work if telephone cables are used to connect the equipment.*
- IEEE 802.3 specification: A network using repeaters between communicating stations (PCs) is subject to the 5-4-3 rule of repeater placement on the network:
  - Five segments connected on the network.
  - Four repeaters.
  - Three segments of the 5 segments can have stations connected. The other two segments must be inter-repeater link segments with no stations connected.

Additional information may be found by searching the web.

## DeviceMaster LEDs

The DeviceMaster has network and port LEDs to indicate status. This subsection discusses:

- [TX/RX LEDs](#)
- [Network and Device LEDs](#) on Page 83

### TX/RX LEDs

This subsection discusses RX and TX LEDs on the DeviceMaster 4-port.

**Note:** DeviceMaster DIN rail models do not have RX/TX LEDs.

The RX (yellow) and TX (green) LEDs function accordingly when the cable is attached properly to a serial device.

- After power cycling the DeviceMaster, the RX/TX LEDs are off.
- The LEDs do not function as described until the port has been opened by an application.
  - If the port is configured for RS-232/422 mode:
    - RX LEDs (yellow) are lit
    - TX LEDs (green) are lit when as the data exits the port
  - If the port is configured for RS-485 mode:
    - RX LEDs (yellow) are lit while receiving
    - TX LEDs (green) are lit during active data transmission

### Network and Device LEDs

The LEDs indicate that the default DeviceMaster application is running. If you have loaded PortVision DX, you can check the DeviceMaster status on-line.

Ports	Model	Network LEDs
1 Panel Mount	Control device	<ul style="list-style-type: none"> <li>• The <b>Status</b> LED on the front of the unit is lit, which indicates that it has power and has completed the boot cycle. <i>Note: The Status LED flashes while booting and it takes approximately 15 seconds for the Bootloader to complete the cycle. When the Bootloader completes the cycle, the LED has a solid, steady light that blinks approximately every 10 seconds.</i></li> <li>• The red <b>Link Act</b> LED is lit, which indicates a working Ethernet connection.</li> <li>• If the red <b>Duplex</b> LED is lit, it indicates full-duplex activity.</li> <li>• If the red <b>100</b> LED is lit, it indicates a working 100 MB Ethernet connection (100 MB network, only).</li> </ul>
1 DIN Rail	EIP-2101 EIP-2201	<ul style="list-style-type: none"> <li>• The <b>Status</b> LED on the front of the unit is lit, which indicates that it has power and has completed the boot cycle. <i>Note: The Status LED flashes while booting and it takes approximately 15 seconds for the Bootloader to complete the cycle. When the Bootloader completes the cycle, the LED has a solid, steady light that blinks approximately every 10 seconds.</i></li> <li>• If the <b>LINK</b> (green) LED is lit, it indicates a working Ethernet connection.</li> <li>• If the <b>ACT</b> (yellow) LED flashes, it indicates network activity.</li> </ul>

Ports	Model	Network LEDs (Continued)
2 DIN Rail	EIP-2102 EIP-2202 EIP-2302 EIP-2402	<ul style="list-style-type: none"> <li>The <b>STATUS</b> LED on the device is lit, indicating you have power and it has completed the boot cycle. <i>Note: The STATUS LED flashes while booting and it takes approximately 15 seconds for the Bootloader to complete the cycle. When the Bootloader completes the cycle, the LED has a solid, steady light that blinks approximately every 10 seconds.</i></li> <li>If the <b>LINK</b> (green) LED is lit, it indicates a working Ethernet connection.</li> <li>If the <b>ACT</b> (yellow) LED flashes, it indicates network activity.</li> </ul>
4 DIN Rail	EIP-2304	<ul style="list-style-type: none"> <li>The <b>STATUS</b> LED on the device is lit, indicating you have power and it has completed the boot cycle. <i>Note: The STATUS LED flashes while booting and it takes approximately 15 seconds for the Bootloader to complete the cycle. When the Bootloader completes the cycle, the LED has a solid, steady light that blinks approximately every 10 seconds.</i></li> <li>If the <b>LINK</b> (green) LED is lit, it indicates a working Ethernet connection.</li> <li>If the <b>ACT</b> (yellow) LED flashes, it indicates network activity.</li> </ul>
4 Panel Mount	Control device	<ul style="list-style-type: none"> <li>The <b>PWR</b> LED on the front of the unit is lit, which indicates it has power and has completed the boot cycle. <i>Note: The PWR LED flashes while booting and it takes approximately 15 seconds for the Bootloader to complete the cycle. When the Bootloader completes the cycle, the LED has a solid, steady light that blinks approximately every 10 seconds.</i></li> <li>The red <b>LNK/ACT</b> LED is lit, which indicates a working Ethernet connection.</li> <li>If the red <b>100</b> LED is lit, it indicates a working 100 MB Ethernet connection (100 MB network, only).</li> </ul>

## Technical Support

If you need technical support use one of the following methods.

Control Contact Information	
Downloads (FTP)	<a href="ftp://ftp.comtrol.com/html/DM_UP_Main.htm">ftp://ftp.comtrol.com/html/DM_UP_Main.htm</a>
Downloads (HTTP)	<a href="http://downloads.comtrol.com/html/DM_UP_Main.htm">http://downloads.comtrol.com/html/DM_UP_Main.htm</a>
Web site	<a href="http://www.comtrol.com">http://www.comtrol.com</a>
Phone	(763) 957-6000